



Philosophische Fakultät

Jana Brunner | Christian Geng | Stavroula Sotiropoulou
Adamantios Gafos

Timing of German onset and word boundary clusters

Suggested citation referring to the original publication:
Laboratory Phonology 5(4)(2014), pp. 403–454
DOI <http://dx.doi.org/10.1515/lp-2014-0014>
ISSN (print) 1868-6346
ISSN (online) 1868-6354

Postprint archived at the Institutional Repository of the Potsdam University in:
Postprints der Universität Potsdam
Philosophische Reihe ; 136
ISSN 1866-8380
<http://nbn-resolving.de/urn:nbn:de:kobv:517-opus4-399178>

Jana Brunner*, Christian Geng, Stavroula Sotiropoulou and
Adamantios Gafos

Timing of German onset and word boundary clusters

Abstract: Previous studies suggest that there are special timing relations in syllable onsets. The consonants are assumed to be timed, on the one hand, with the vocalic nucleus and, on the other hand, with each other. These competing timing relations result in the *C-center effect*. However, the C-center effect has not consistently been found in languages with complex onsets. Moreover, it has occasionally been found in languages disallowing complex onsets. The present study investigates onset timing in German while discussing alternative explanations (not related to bonding) for the timing patterns observed. Six German speakers were recorded via Electromagnetic Articulography. The corpus contained items with four clusters (/sk/, /kv/, /gl/, and /pl/). The clusters occur in word-initial position, word-medial position, and across a word boundary preceding different vowels. The results suggest that segmental properties (i.e., oral-laryngeal coordination, coarticulatory resistance) determine the observed timing patterns, and specifically the absence or presence of the C-center effect.

Keywords: C-center, gestural coordination, oral-laryngeal coordination, coarticulatory resistance

DOI 10.1515/lp-2014-0014

*Corresponding author: **Jana Brunner:** Universität Potsdam. Currently at Humboldt-Universität zu Berlin. E-mail: jana.brunner@hu-berlin.de

Christian Geng: Universität Potsdam. E-mail: geng@uni-potsdam.de

Stavroula Sotiropoulou: Universität Potsdam. E-mail: stsotiro@uni-potsdam.de

Adamantios Gafos: Universität Potsdam. E-mail: gafos@uni-potsdam.de

1 Introduction

1.1 Gestural coupling relations in syllable onsets: The C-center hypothesis

The temporal organization of syllable onsets in English has been described by the term *C-center stability*. Browman and Goldstein (1988) were the first to show that, comparing an English CVC sequence such as *pats* and an English CCVC sequence such as *spats*, the interval from the temporal midpoint of the singleton onset C in *pats* to the onset of the coda C is comparable in duration to the interval between the temporal midpoint of the complex onset CC in *spats* to the onset of the coda C (cf. Figure 1). The /p/ in *spats* is shifted towards the vowel; as shown in Figure 1, it overlaps more with the vowel than the /p/ in *pats*. The temporal midpoint of the cluster or singleton has been termed the *C-center*. The beginning of the coda, or in some studies, alternatively, the target of the vowel or the acoustic offset of it, has usually been termed the *anchor*. Importantly, C-center stability is assumed to exist in onsets but not in codas. If one compares the timing of *spat* and *spats*, the coda /t/ in *spats* is not closer to the vowel than the coda /t/ in *spat*.

The theoretical interpretation of this finding in articulatory data is that onset consonants are linked to the vowel differently than coda consonants. For onset consonants, it is assumed that each consonant on its own is in a timing relation to the vowel (CV timing), whereas in codas only the post-vocalic consonant is

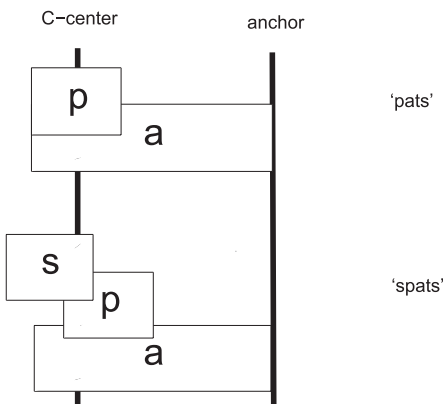

Fig. 1: Schematization of C-center stability. The interval from the C-center of the onset to the anchor (target or offset of the vowel or beginning of the coda) is stable for onsets of different complexity. Adapted from Marin and Pouplier (2010).

timed with the vowel (VC timing). If this CV-timing relation were the only timing relation in the sequence, the two onset consonants would be produced simultaneously since both consonants are in the same timing relation with the vowel. However, the onset consonants are also in a timing relation with each other (CC timing). This additional timing relation causes the consonants to be produced sequentially. The competition among these timing relations leads to gestural overlap of, on the one hand, the consonants with each other and, on the other hand, the prevocalic consonant with the vowel. A first expression of syllable structure in terms of such timing relations is Browman and Goldstein (2000), who introduce CV and CC ‘bonds’ of different strengths and some notion of least-square optimization when bonds are at odds. In a second analysis, Gafos (2002) shows how these temporal outcomes can be derived from the interaction of violable and competing CV, CC, and VC coordination constraints in language-specific grammars of gestural coordination. A third analysis has been given in terms of coupled oscillators, where timing relations are stated using the notion of phase, in Nam and Saltzman (2003). In all these analyses, competition between bonds, coordination constraints, or phase relations result in a temporal organization in which it is the C-center of the entire onset consonantism, be it C or CC, which is most stably timed to the subsequent vowel.

We illustrate these ideas with some examples, following the description in the coupled oscillators model of Nam and Saltzman (2003) and Goldstein et al. (2009). In this model, each gesture is associated with an abstract oscillator, which determines the evolution of the dynamic event (corresponding to the gesture) in time and space. Any oscillating system is associated with an abstract 360-degree cycle and has a well-defined notion of phase. A phase corresponds to a point on the cycle of the oscillator and is measured by an angle in degrees (see Hawkins [1992] for discussion). In the coupled oscillators model, timing relations between gestures are expressed by coupling relations, which in turn are stated in terms of synchronizing phase values within the abstract cycles of the gestural oscillators. Two coupling or phasing relations are assumed, in-phase and anti-phase. If two gestures are coupled in-phase, their relative phase angle is 0 degrees, meaning the gestures start at the same time. If two gestures are coupled anti-phase, their relative phase angle is 180 degrees. A gesture which is timed anti-phase to another one does not start before the first gesture is finished (i.e., they are sequentially timed). In the gestural representation of a lexical item in this model, the totality of coupling relations is represented by a coupling graph.

Figure 2a shows a coupling graph adapted from Goldstein et al. (2009) for the English word *mad*. The nasal is represented by a velar gesture and a lip closure gesture, the vowel by a tongue body gesture, and the final stop by a tongue tip gesture. The solid lines represent in-phase coupling of gestures, the dashed lines

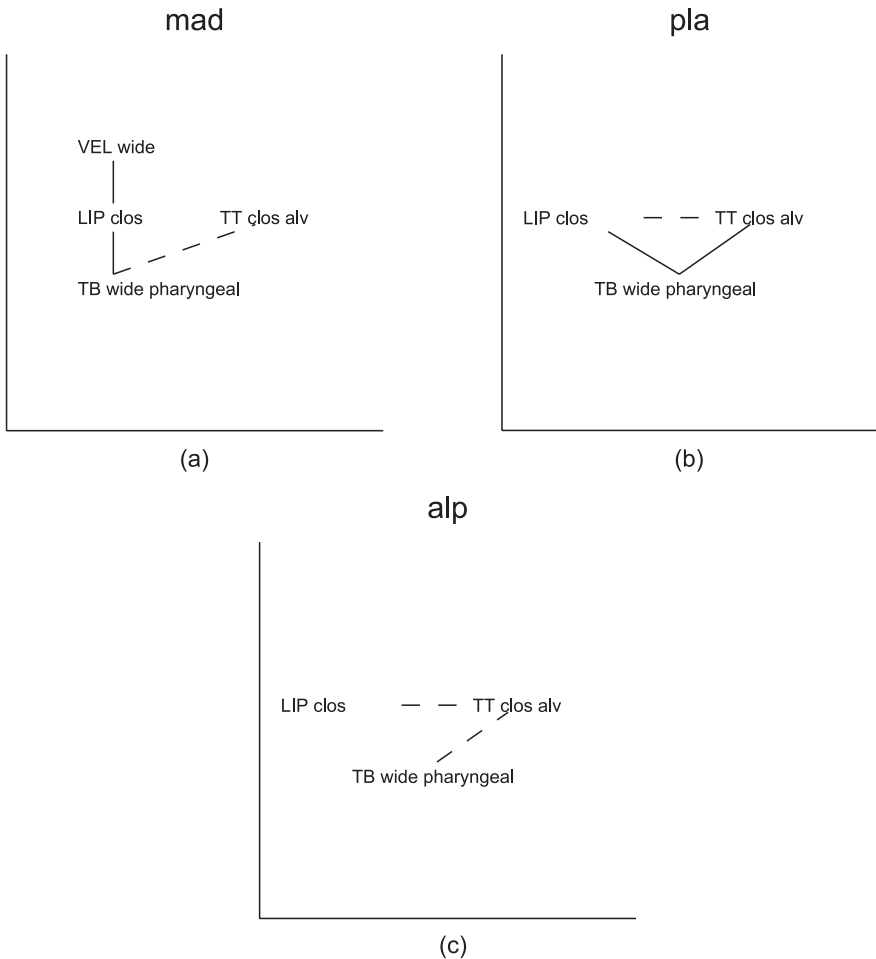

Fig. 2: Coupling graphs for (a) the English word *mad* (adapted from Goldstein et al. 2009), (b) the German syllable onset and nucleus /pla:/, and (c) the German syllable nucleus and rime /alp/. Solid lines: in-phase coupling; dashed lines: anti-phase coupling.

anti-phase coupling. According to this coupling graph, the onset consonant is timed in-phase with the vowel, meaning that the velar gesture, the lip closure gesture, and the tongue body gesture start at the same time. The tongue tip gesture is timed anti-phase with the tongue body gesture, meaning it starts its movement when the tongue body gesture has finished its own movement.

Figure 2b shows a coupling graph for the German syllable *pla*, as it occurs in the word *plagen*, which is one of the words that will be analysed in the pres-

ent paper. The lip closure gesture of /p/ is timed in-phase with the vowel (TB gesture), but the tongue tip gesture for /l/ is also timed in-phase with the vowel. These two gestures, therefore, should start at the same time. The coupling between the lip and the tongue tip gesture, however, is anti-phase, so they should start one after the other. This leads to competitive coupling, and the resulting gestural timing is, according to the coupled oscillator model, the C-center effect: there is gestural overlap of the tongue tip and the tongue back gesture since they are timed in-phase with each other. The lip gesture, which is also timed in-phase with the vowel, however, is not synchronous with the tongue tip gesture since there is additional anti-phase coupling between the tongue tip and lip gesture.

Figure 2c shows the coupling assumed for the nucleus-coda sequence /alp/. All the segments are timed anti-phase with each other and are therefore produced in sequence.

There are numerous studies that have looked for experimental evidence for gestural coupling relations in onsets. Browman and Goldstein (1988) investigated /pl/, /sp/, and /spl/ within onsets (*plats*, *spats*, *splats*) and across word boundaries (*pis plats*, *pi plats*). X-ray microbeam data of a single speaker were aligned at the anchor consonant (first coda consonant in *plats*). Interval durations were calculated from the left edge (the beginning of the clusters or singleton consonants) to the anchor, from the C-center to the anchor, and from the right edge (the end of the cluster or singleton consonant) to the anchor. Standard deviations were calculated across the intervals of both singleton and cluster onsets. The standard deviation of the C-center to anchor interval was found to be lowest. The clusters crossing word boundaries were aligned at the onset of the preceding syllable (i.e., first /p/ in *pis plats*). If in-phase coupling of the entire cluster (/s/, /sp/, /spl/) to the preceding vowel existed, one would again expect the C-center to anchor interval to be most stable. Standard deviations across singleton and cluster utterances show, however, that the left edge (beginning of the onset of the second syllable, i.e., /s/) was the most stable interval in these clusters. This method, whereby standard deviations of intervals are calculated, will be termed *stability analysis* in the present paper.

Honorof and Browman (1995) showed in x-ray microbeam data of four American English speakers producing the onset clusters /sp/, /sps/, /pl/, and /spl/ and the coda clusters /ps/, /sps/, /lp/, and /lps/ that the C-center to anchor interval was the most stable one in onsets but not in codas. Goldstein et al. (2009) discussed articulatory data of six speakers of English and two speakers of Georgian and carried out a shift analysis, which determines how far the prevocalic consonant of the cluster has moved ‘into the vowel’ or overlaps with the vowel. This rightward shift was determined by calculating the duration from the achievement

of the target of the prevocalic consonant to the vowel for the CCV and the CV items and then calculating the difference between these two durations. A leftward shift of the cluster was determined by first calculating the lag between achievement of the target of the initial consonant and the vowel and then calculating the difference between these intervals in the CCV and the CV items. The results showed that the English clusters /pl/ and /sp/ differed in the degree of shift of the prevocalic consonant towards the vowel (rightward shift) and the degree of shift of the initial cluster consonant towards the left. Whereas in /sp/, rightward and leftward shifts were found to have a comparable magnitude, there was a greater leftward than rightward shift in /pl/. In order to explain this finding, the authors adapted the gestural coupling graph for CCV sequences set up in earlier studies. For /l/ they assumed that two tongue gestures, an alveolar and a dorsal one, are coupled to the vowel, resulting in a different timing in /pl/ as compared to /sp/. For Georgian, Goldstein et al. (2009) found that there was a shorter lag between the consonantal plateaus in front-back clusters, such as /bg/, than in back-front clusters, such as /gb/. Again, two different coupling graphs, which include separate links for closing and release gestures, were suggested to underlie these clusters.

Marin and Pouplier (2010) investigated seven English speakers, but with a greater range of analyses. In this study, onsets and codas (not going across a word boundary) were investigated. A stability analysis showed that the C-center to anchor interval was more stable than both the left edge to anchor and the right edge to anchor intervals. For codas, the left edge to anchor interval was the most stable interval. This result was largely supported by a shift analysis.

Marin and Pouplier (2010) also carried out a third analysis on their English data, which we will call *vowel compression analysis*. This analysis looked at vowel length in singleton and cluster items as a measure of vowel compression. If there is a C-center effect, one would expect the vowel to be shorter (= more compressed) in cluster items than in singleton items. In onset clusters, vowel compression was generally observed. For codas there was also compression, but only for /lk/ and /lp/. For the other clusters, the vowel length remained unchanged.

Most studies investigating languages other than English present inconsistent results. Goldstein et al. (2007) carried out a vowel compression analysis on data of two Georgian speakers. For one of the speakers, vowel compression in the cluster item was found; for the other speaker, however, the vowel duration stayed constant.

Hermes et al. (2008) investigated the timing of onset consonants in two Italian speakers. Italian has been characterized as a language allowing complex onsets such as /pr/ but having extrasyllabic /s/ ('impure /s/') in clusters such as

/spl/ where a sonority reversal occurs. Hermes et al. hypothesized that there should be a C-center effect in clusters without impure-s (e.g., comparing /l/ with /pl/ onsets), but not in clusters with impure-s (e.g., comparing /p/ with /sp/ onsets). The results are mostly in line with the hypothesis. The C-center to anchor interval was stable in most sequences not involving impure-s. If impure-s was involved, there was no C-center effect.

Quite a number of studies report both patterns in a single language. Marin (2011) investigated onset clusters in five Romanian speakers. The results were mixed. Whereas /sp/, /sm/, and /sk/ clusters, and arguably also /pl/ and /kl/, showed a C-center effect, /ks/, /kt/, /kn/, and /ps/ clusters did not. Pouplier (2012), in discussing Marin (2011)'s data, suggests that an effect of coarticulation resistance of the prevocalic consonant on the initial consonant of the cluster interacts with the C-center effect: clusters with high coarticulatory resistance do not show the effect, whereas clusters with low coarticulatory resistance show it.

Pouplier (2012) tested the C-center effect on data of four German speakers in onset clusters (/bl/, /pl/, /gm/, /km/, /sk/) and coda clusters (/lm/, /lp/, /bt/, /ks/, /kt/). Results of a shift analysis suggest that the prevocalic consonant moved towards the vowel in /sk/-onsets. The shift was equal in magnitude to the shift of the initial cluster consonant towards the right. /km/, /gm/, and /bl/ showed a very small shift of the prevocalic consonant, and for /pl/ a shift in the opposite direction was found. Coda consonants exhibited shifts towards the vowel in /lm/, /lp/, and /ks/, but these shifts were very small. In /kt/ and /bt/, the vowel-adjacent consonant even moved away from the vowel. Nevertheless, Pouplier claims that coda timing is fundamentally different from onset timing in German, even if segmental properties seem to play a role. The stability analysis revealed no significant difference between right-edge and C-center standard deviations for onsets but a significant difference between left-edge and C-center standard deviations for codas. Pouplier also carried out an overlap analysis by calculating the overlap (or, in most cases, rather the lag) between the gestural plateaus of the two cluster consonants. A relation between overlap and C-center patterns was observed: C-center stability was mostly found for clusters with much overlap.

Apart from these studies where both right-edge stability and C-center stability were found, there exist languages which seem to exhibit right-edge stability predominantly, such as Berber (Goldstein et al. 2007; Hermes et al. 2011) and Moroccan Arabic (Shaw et al. 2009; Shaw et al. 2011). In agreement with the phonological literature on Berber and Moroccan Arabic (Dell and Elmedlaoui 1996), these experimental studies provide converging evidence that these languages do not allow for more than a single consonant as part of the syllable onset (simplex onsets).

1.2 Beyond the C-center effect

The review of earlier studies shows that the previous analysis types (i.e., stability analysis, vowel compression analysis) have not been totally successful in showing a C-center effect in languages that have been described as allowing complex onsets. The work by Pouplier (2012) especially has shown that segmental properties play a role for stability indices. Virtually all studies report differences between clusters. The aim of the present study, which takes a look at German again, is therefore to investigate how segmental properties influence C-center stability. The main claim of the paper is that the timing patterns that have been termed *C-center stability* and that have been interpreted as the result of competing bonding relationships in syllables can alternatively be explained by the phonetic properties of the segments involved. It will be shown that the methods used for determining stability indices are all sensitive to segmental properties and that it is therefore not clear whether a stability index is the outcome of a phonological parse or the result of the phonetic properties of the segments involved.

The rest of the introduction deals with phonetic mechanisms that possibly influence the measures used in previous studies for analyzing C-center stability.

1.2.1 Onsets versus codas

In a number of studies, onsets have been compared to codas. Marin and Pouplier (2010), for example, compare /sk/ in the onset with /ks/ in the coda. The underlying argument is that if onsets are different from codas, a different gestural timing must be involved in onsets as compared to codas. A fundamental issue with this reasoning is that, phonetically, a coda is not simply the mirror image of an onset. Two examples will demonstrate this. The cluster /sk/ contains a velar stop. For intervocalic velar stops, it has been shown that there is usually a looping movement. During this movement the tongue slides along the palate, usually from a more retracted point towards a more fronted point (e.g., Mooshammer et al. 1995; Brunner et al. 2011), although backward looping occurs depending on the vowel context and the speaker. Informal observations on the data discussed in this study suggest that there is forward looping during the velar stop in /sk/ as well, even with a smaller movement amplitude. No data have been reported on coda /ks/, but since forward looping is the dominant pattern in velar stops and the tongue necessarily has to move towards the front in order to come from /k/ to /s/, it is likely that there would be forward looping in /ks/ as well. As a consequence of this, the articulatory movements in /sk/ and /ks/ are not mirror images

of each other. The path the tongue travels during the cluster is longer in /sk/ than in /ks/ because in /ks/ the tongue's sliding movement at the palate leads it directly into the /s/ configuration, whereas in /sk/ the tongue moves from the alveolar configuration towards forming the velar closure and then back towards the front during the sliding movement. Because the movement amplitude is larger in /sk/ than in /ks/, it consequently takes longer and this influences the stability indices.

Similarly, /pl/ is not the mirror image of /lp/. One reason for this is that, at least in English, /l/ in onsets tends to be clear whereas /l/ in codas tends to be dark (e.g., Giegerich 1992). Accordingly, onset /l/ and coda /l/ are two different sounds. Sproat and Fujimura (1993) suggest that /l/ consists of an alveolar and a dorsal gesture. In clear /l/ the alveolar gesture, as measured in their data, precedes the dorsal gesture. In dark /l/ the alveolar gesture follows the dorsal gesture. According to this view, if an onset /l/ is indeed clear and a coda /l/ dark, the two sounds tend to be mirror images. However, Sproat and Fujimura furthermore suggest that clear and dark /l/ are only the ends of a continuum of /l/ sounds that can be found in speech and many /l/ sounds are somewhere in between the two extremes. In this case the two sounds are not necessarily mirror images of each other, and it thus may be premature to assume that differences between onsets and codas have their origin in different bonding relations.

1.2.2 Word boundary effects

As an alternative to comparing onsets and codas, one could compare onset clusters and clusters going across a word boundary. If the consonants of a cluster belong to two syllables, as is the case when there is a word boundary in the middle of the cluster, there should be no competing bonding relations. The timing in these clusters should therefore be different as compared to the timing in onset clusters (all other things being equal). We therefore decided to compare within-syllable clusters (for example /sk/ in *skypen*) with across-syllable clusters (for example /sk/ in *lass Keime*). A similar analysis has already been carried out by Byrd (1995) for word boundary clusters in English. German seems to be a more suitable language for this comparison than English since German is more restricted with regard to resyllabification (McCarthy and Prince 1993).

What has to be kept in mind when analyzing word boundary clusters, however, is that in those clusters the segments can be assumed to bear word-boundary markers. Redford (2007) reports that English coda consonants preceding word boundaries are reduced in length and aspirated stops lose their aspiration. In word-boundary clusters, the first element can therefore be expected to be shorter

than in onset clusters. This could lead to a C-center effect when a stability analysis is carried out. A vowel compression analysis, however, should reveal that there is right-edge stability in those clusters.

Relatedly, word-initial clusters as well are influenced by word-boundary markers. Still, previous studies investigating the C-center effect in languages admitting complex onsets have concentrated on word-initial clusters. In order to investigate syllable structure without confounding effects of word edges, we decided to record word-medial, syllable-initial clusters in addition to word-initial clusters.

1.2.3 Oral-laryngeal coordination

A factor that might influence gestural timing is oral-laryngeal coordination. Numerous studies (for a comprehensive overview, see Hoole [2006] and references therein) have shown that oral-laryngeal timing differs in clusters as compared to singletons. For German, Hoole shows that there is usually one laryngeal opening and closing gesture during an onset, no matter how many consonants the onset consists of. In a cluster such as /sk/, this glottal opening gesture is comparable in duration to the one in singleton /k/. As a result of that, singleton /k/ is aspirated in German whereas the /k/ in the cluster /sk/ is not. In word-boundary clusters there are two primary glottal opening-closing gestures (e.g., Yoshioka et al. 1981; Ridouane et al. 2006), resulting in an aspirated /k/ in the /s#k/ cluster. This should result in decreased C-center stability in the word boundary case. In order to investigate how oral-laryngeal timing influences stability indices, clusters differing in oral-laryngeal timing will be compared in this study.

1.2.4 Consonant-consonant coarticulation

For a C-center effect to emerge, ideally two conditions must be fulfilled. First, the prevocalic consonant must be able to overlap with the vowel, leading to vowel shortening, as has been shown in vowel compression analyses. The second condition has been discussed in Pouplier (2012): the consonants should be able to overlap with each other. In her overlap analysis, Pouplier showed that a C-center effect is more likely to be found if the lag duration between the two consonantal plateaus is small. A small lag causes the initial consonant of a cluster to be closer to the prevocalic consonant and this reduces the variability of the C-center to anchor interval. Whereas stability analyses are sensitive to both conditions, vowel compression analyses are sensitive to the first condition only.

Hoole et al. (2009) showed for three German speakers that there was a larger C1-C2 lag in clusters with a voiceless initial consonant (/kl, kn, pl, pn/) than in clusters with a voiced initial consonant (/gl, gn, bl/). The most straightforward explanation for that finding would probably be that the initial consonants are aspirated, and the aspiration requires a non-constricted vocal tract.¹ As a result of that, the prevocalic consonant is delayed. This hypothesis was tested by Bombien and Hoole (2013). They compared lag durations in German and French /kl, gl, pl/ and /bl/. Since French voiceless stops are described as not being aspirated, the lag duration of French /kl/ and /pl/ was expected to pattern with German /gl/ and /bl/. What was found, however, was that French clusters were very similar to German clusters: large lags in /kl/ and /pl/ and smaller ones in /bl/. The lag duration for /gl/ differed for the two languages: a greater lag was found for French than for German. This finding is in line with an earlier one by Pouplier (2012), which reports about the same lag duration for /bl/ as for /pl/ (her Figure 3). As an explanation for this finding, Bombien and Hoole (2013) discuss different oral-laryngeal coupling relations. Whereas in German clusters, all oral gestures are assumed to be coupled to one laryngeal gesture, in French, each oral gesture has its own coordination with a glottal gesture.

1.3 Consonant-vowel coarticulation

Although extensive work on coarticulation exists, previous C-center studies largely seem to ignore the fact that the ability of consonant and vowel to overlap influences the measure of C-center stability. According to Recasens' degree of articulatory constraint (DAC) model (e.g., Recasens et al. 1997), sounds with a high "degree of involvement of the tongue dorsum in closure or constriction formation" (544), such as /s, ʃ, k/, exert much influence on the surrounding vowels (coarticulatory aggressiveness) and are themselves rather resistant to the influences of surrounding sounds (coarticulatory resistance).

To give an example, in sequences such as /asa/ and /isi/, the sound with more involvement of the tongue back, namely the consonant, influences the surroundings (the vowels) more than those vowels influence the consonant. As a result, the variability of /s/ across the two contexts is low. In contrast to that, in a sequence pair such as /apa/ and /ipi/, the consonant has low coarticulatory

¹ If the vocal tract were constricted, the intraoral air pressure would increase, decreasing the velocity of the airstream and thus eliminating the turbulences that cause the aspiration noise.

resistance and low coarticulatory aggressiveness. The tongue position during the consonant is determined entirely by the surrounding vowels. As a result, tongue positions vary more in /apa/ vs. /ipi/ than in /asa/ vs. /isi/. Thus, a sound with high coarticulatory resistance and aggressiveness is a sound that stays relatively stable when its surroundings vary. Sounds that are less resistant might assimilate to the aggressive sound, and this could be interpreted as a difference in gestural overlap: in /apa/ the vocalic gestures largely overlap with the labial gestures, whereas in /asa/ the gestures are more separate from each other.

Sounds such as /k, g, s, ʃ/ have been shown to be highly resistant sounds. Sounds such as /n/ have been shown to have an intermediate resistance. They can exert influence on sounds that have an even lower resistance, such as bilabials, but they are influenced by sounds with a higher resistance (see Recasens et al. 1997; Recasens 1999, 2012). If coarticulation results in place assimilation, this changes the paths from the preceding sounds to the target sound and from the target sound to the following sound. The movement amplitude of these paths, and consequently the movement duration, changes, and thus the timing of the entire sequence might be affected. In a CCV sequence, for example, the CV movement could decrease in amplitude due to the coarticulatory influence of the initial C. This could happen when the initial consonant changes the articulatory configuration of the prevocalic consonant so that it is closer to the configuration of the vowel. As a result of that, a C-center effect might emerge because the distance the articulators have to travel to reach the vocalic position is shorter in the CCV than in the CV sequence.

Related to that, Lehiste (1970) discusses differences between short and long vowels in Czech and Serbo-Croatian. As in German, vowel quantity differences in these languages are linked to quality differences. Lehiste argues that the duration of the vowel might depend on the articulatory distance between the vocalic position and the following consonantal position. For Czech high vowels, she shows that there is only a small quantity difference between short and long vowels, but the greater the positional difference between the short and the long vowel, the greater the quantity difference. Lehiste generalizes that “the duration of a vowel depends on the extent of the movement of the speech organs required in order to come from the vowel position to the position of the following consonant” (20).

Lehiste discusses VC movements, but if the same relation should hold for CV movements, this could have an influence on stability indices. This possibility is schematized in Figure 3. Figure 3a schematizes the classical C-center effect as it is usually described to arise from competing bonding relations leading to more overlap of the prevocalic consonant and the vowel in the CCV item. Figure 3b shows a C-center effect resulting from differences in movement amplitude in the

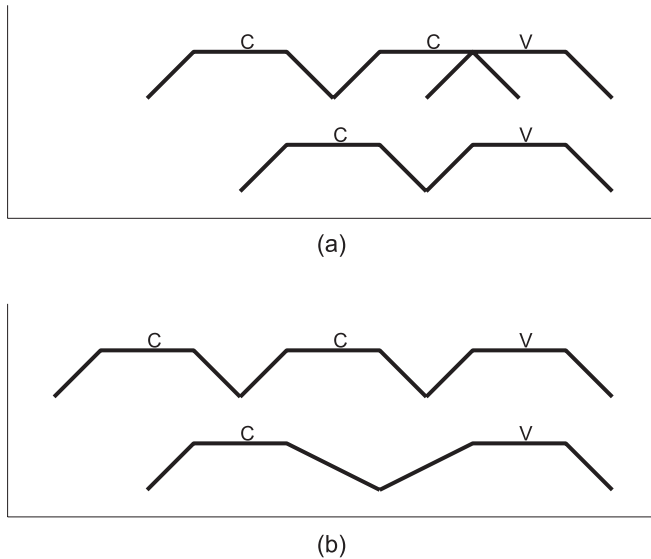

Fig. 3: Schematized articulatory movements in CCV and CV sequences. (a) C-center effect resulting from competing bonding relations. (b) C-center effect resulting from differences in CV movement amplitude in the CV as compared to the CCV item.

CV movement. Suppose that the vowel target in the CV item is farther away from the consonantal target than the one in the CCV item. If so, then the movement from C to V takes longer in the CV case than in the CCV case.

To give a more concrete example, if one compares the length of a high vowel such as /e/ in German *sah queren* /za: kvɛ:rən/ and *sah wehren* /za: vɛ:rən/, the /e/ in *queren* might be shorter because the tongue does not need to travel as far from /k/ to /e/ as from /a/ to /e/. This paper examines the extent to which such factors contribute to the C-center effect.

1.4 Summary and outline

The aim of the present study is to investigate gestural timing in German singleton and cluster onsets in word-initial and word-medial syllables. Initial and medial syllable onsets will be compared to clusters going across a word boundary. According to the C-center hypothesis, a C-center effect should be observed in syllable onsets. The influence of segmental properties (oral-laryngeal coordination and coarticulation) on stability indices and vowel compression will be investigated.

Throughout this paper, the initial consonant of a CCV sequence will be called *initial consonant* (even if the cluster occurs word medially or across a word boundary), and the prevocalic consonant of a CCV sequence will be called *prevocalic consonant*. The consonant of a CV sequence will be called *singleton consonant*.

2 Methods

2.1 Subjects

Six German native speakers, three males and three females, participated in the experiment. The speakers were between 20 and 33 years old and without any present or past speech or hearing problems. They were recruited at the University of Potsdam and paid for their participation in the experiment. All procedures were performed in compliance with relevant laws and institutional guidelines and were approved by the Ethical Committee of the University of Potsdam. Informed consent was obtained from all subjects.

2.2 Speech material

The following clusters were recorded: /gl/, /kv/, /pl/, and /sk/. The clusters were selected according to the following criteria (ordered in decreasing relevance):

- Heterorganicity of the consonants: homorganic clusters such as /ft/ were not recorded since it is not possible to measure separate articulatory movements to these consonants.
- Diversity in the ability to coarticulate: bilabials that are easily influenced by surrounding sounds and velar stops that are not as easily influenced occur as initial and prevocalic consonants.
- Diversity in the manner of articulation: the clusters contain stops, fricatives, and approximants.
- Diversity in voicing conditions: there are clusters which are phonologically fully voiced (/gl/), partly voiced (/kv²/, /pl/), and voiceless (/sk/).

2 The cluster /kv/ is argued to have a special phonological status in German since there are no other stop-fricative clusters that can occur in syllable onsets. Wiese (1996), for example, argues that its underlying form is /kv/, although the second element is frequently fully or partly devoiced. The speakers in our study usually produced /v/ either without voicing or with voicing towards the end of the cluster.

The clusters were recorded in different positions of the word, preceding vowels of different lengths, and in two different accentuation conditions. In order to reduce the recording time and thereby the risk of sensor detachment, not all clusters were recorded for all speakers. The /pl/ series was recorded for all six speakers, the /gl/ series for five speakers, the /sk/ series for four speakers, and the /kv/ series for three.

Position in the word. Each of the clusters and the corresponding singletons were recorded in three positions, namely word initially, word medially, and around a word boundary. An example for an item with a /pl/-cluster in initial position is *plagen*; the corresponding singleton is *lagen*. An example for a cluster in word-medial, syllable-initial condition is *geplagt*; the corresponding singleton is *Gelage*. For these two conditions, the C-center hypothesis would predict a C-center effect since it is assumed that the onset consonants are all timed with the vowel. The clusters were also recorded across a word boundary, for example in *knapp lagen*, where the first cluster consonant (here /p/) is at the end of one word and the second cluster consonant (here /l/) occurs in the onset of the second word. This third condition was recorded for three clusters only (/pl/, /sk/, and /kv/) because German has final devoicing so that /gl/ would have been produced as [k#] in this condition.

Vowel type. In order to investigate the influence of vowel length and position on stability indices, all clusters were recorded preceding vowels of different lengths and different tongue position, namely tense vowels, diphthongs, and lax vowels. To give an example, initial /pl/ was recorded in *plagen* with tense /a/, *Plätze* with lax /ɛ/, and *plauschen* with the diphthong /aʊ/. This vowel variation resulted in anchor consonants that were either ambisyllabic (*Plätze*) or belonged to the following syllable (e.g., *plagen*). There is also a single monosyllabic item (*Skat*) where the anchor is fully contained in the syllable. The variation between ambisyllabic consonants and consonants belonging to the following syllable is due to the tendency of German syllables with tense vowels or diphthongs to be open, and the fact that syllables with lax vowels are always closed unless they are unstressed. This variation in the syllable affiliation of the anchor consonant, however, had no influence on the measures we carried out because we were comparing items with comparable anchors. For example, in *plagen* vs. *lagen*, the anchor of both words is in the second syllable. *Quelle*, with an ambisyllabic anchor is compared to *Welle*, which also has an ambisyllabic anchor. There are two problematic cases, i.e., *Skat-Kater* and *geplagt-Gelage*, where the syllable affiliation of the anchor consonant differs within a pair. The reason for choosing these pairs was to avoid using nonsense words. For /gl/, instead of a tense vowel series, two series of diphthongs were recorded.

Accentuation. Accentuation changes mainly the vowel length (e.g., Beckman 1986), but it may also change the duration of the other segments of a syllable (e.g., Campbell and Isard 1991; Kohler 2005). In order to investigate whether this durational variation influences stability indices, each item was recorded in two different carrier phrases. In one of the phrases, the items bore sentence accent (*Ich sah ... an* ‘I looked at ...’), and in the other it did not (*Ich sah mit Tom, nicht mit Anna ... an*. ‘I looked at ... with Tom, not with Anna.’). The subjects were instructed to imagine the words printed on a sign so that the sentences were syntactically correct.

Items were chosen so that the coda consonant or the onset consonant of the following syllable is measurable on articulatory data (i.e., a lingual or labial consonant). Since we aimed at recording real words instead of nonsense words, the anchor consonants of some pairs are not the same sounds. An example is *skypen-Keime*. However, in all these cases, the place of articulation and the articulator are the same.

There were eight repetitions of each item in each condition. Each speaker was recorded speaking three clusters only (instead of all four), resulting in 576–720 trials (3 clusters, 12 or 15 items, 2 accentuation conditions, 8 repetitions), which were recorded together with other material. A list of all items is given in the Appendix (Table A.1).

2.3 Data acquisition and processing

Our corpus consists of oral motion data acquired by means of Electromagnetic Articulography (EMA) using the Northern Digital Inc. (NDI) Wave System. The Wave system is designed to track articulatory motion over time by attaching sensors to various locations in the vocal tract. It acquires data through the system control unit and the Wavefront software hosted on a dedicated computer (the desktop computer on the right in Figure 4). Three sensors were attached midsagittally to the tongue: the front-most sensor (TT) was positioned roughly 1 cm behind the actual tongue tip, the rear-most sensor (TB) as far back as possible without creating discomfort for the participant, and the third sensor (TM) such that its distance from TM and TB was roughly equal. Figure 4 (top) contains an anatomical sketch detailing these sensor locations.

Articulatory data were acquired at a sample rate of 400 Hz; the resulting position data were low-pass filtered with a Kaiser window and converted into MATLAB’s binary format prior to any further processing. For the reference sensors (right and left ear, bridge of nose, and maxilla), the filter cutoff was set to 5 Hz, and to 20 Hz for all the other sensors (lips and jaw, all tongue sensors, including

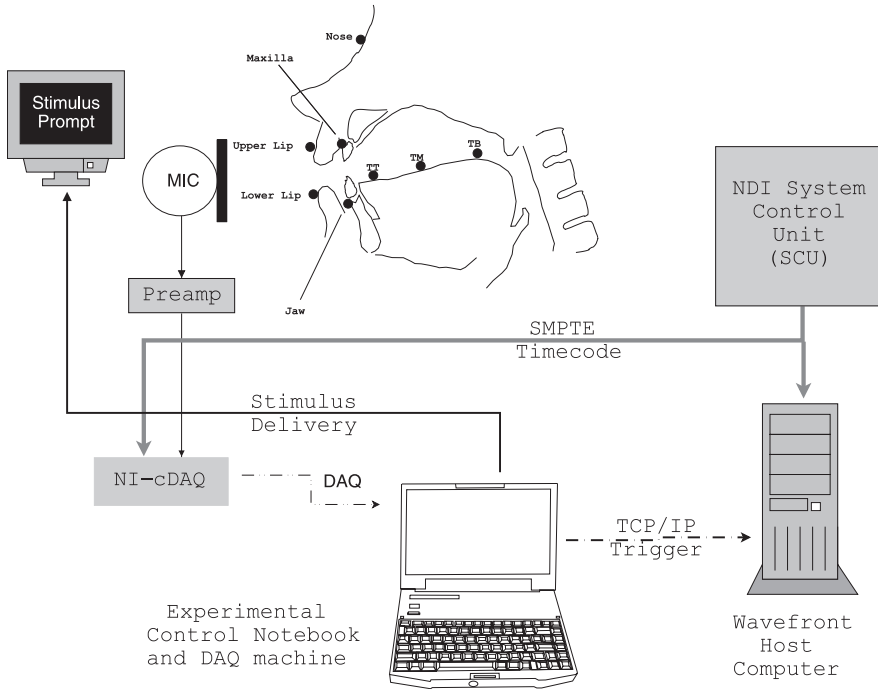

Fig. 4: Overview of the experimental setup. The experimental control notebook (bottom) controls stimulus presentation, audio, and synch data acquisition and also triggers the NDI system via a Real Time API. The top shows an anatomical sketch detailing sensor placement. For a more detailed description, see text.

the tongue tip). In the following step, the contributions of head movement were removed from the measured data on a frame-by-frame basis. On the basis of these elementary sensor data, we calculated a composite measure of lip aperture consisting of the Euclidean distance between the anterior-posterior and longitudinal components of the upper and lower lip signals, excluding the lateral dimension of motion from the calculation.

Horizontal, vertical, and tangential velocities were calculated using a filter that was obtained by convolving a differentiation kernel with filter coefficients of a low-pass filter with 20 Hz passband and 30 Hz stop band edges (again using a Kaiser window).

Audio data were simultaneously captured at a sampling rate of 25.6 kHz using the Schöps Colette modular system of microphones (consisting of a CMC 6-Ug SG 20 Microphone Amplifier, a microphone capsule MK 2Sg with an omnidirectional characteristic, and a VSR 5 Core Microphone Preamp). The acoustic signal

was captured using a National Instruments Modular data acquisition (DAQ) system consisting of a Compact DAQ 4-slot chassis (NI cDAQ-9174) and an NI-9234 acquisition board that performed anti-alias filtering of the input signal. The data acquired by this subsystem was fed into our experimental control notebook (see the bottom of Figure 4). This notebook is the central component of our setup: it not only controls the DAQ system but also (i) the stimulus presentation on a separate screen (Figure 4, top left) and (ii) the recording status (on/off) of the NDI Wave device via the NDI Real Time API using the TCP/IP protocol.

In order to be able to synchronize our audio data with our motion data, we developed our own synchronization solution. This became necessary, as the NDI critically hinges on the use of a sound card mounted in the Wavefront host computer, i.e., either on the built-in sound card or a soundblaster-compatible card mounted via, for example, USB. In order to be able to use a dedicated DAQ system, we duplicated the NDI Wave's SMPTE synchronization signal that is generated by the Wave system's NDI System Control Unit (SCU); we acquired this signal with both (i) the internal sound card of the computer hosting the Wavefront software and (ii) our NI DAQ system. This was achieved by soldering a custom cable that splits the signal and directs it to both the DAQ system and the internal sound card. The synchronization signal generated is an SMPTE code with 25 frames per second, and it was extracted offline from both sources. In the next step, we identified the earliest and the latest synchronous frame in our DAQ for each trial and used that information to extract from audio data synchronized with the motion data.

2.4 Articulatory segmentation

For each of the singleton and cluster onset consonants and for each anchor consonant (the first coda consonant), an articulatory movement was measured. Table 1 lists all the consonants with the sensors on which the measurements were carried out. For the production of /s/, for example, the tongue tip is most

Table 1: Consonant-sensor mapping for articulatory segmentation.

Consonants	Sensor
/l, t, s, n, ʃ/	tongue tip
/g, k, r/	tongue back
/p, b/	lip aperture
/v/	lower lip

involved, and the movement was consequently measured on the tongue tip sensor. The /r/-gesture was measured on the tongue back sensor because German /r/ is a dorsal sound, at least in Northern German, the variety spoken by our participants.

Measurements were carried out semi-automatically using *mtnew* (Hoole 2007), a MATLAB-based program for the analysis of articulatory data. An example for a measurement of a tongue back gesture for /k/ can be seen in Figure 5. The figure shows (a) the acoustic signal, (b) the anterior-posterior movement of the tongue back sensor, (c) the vertical movement of that sensor, (d) the

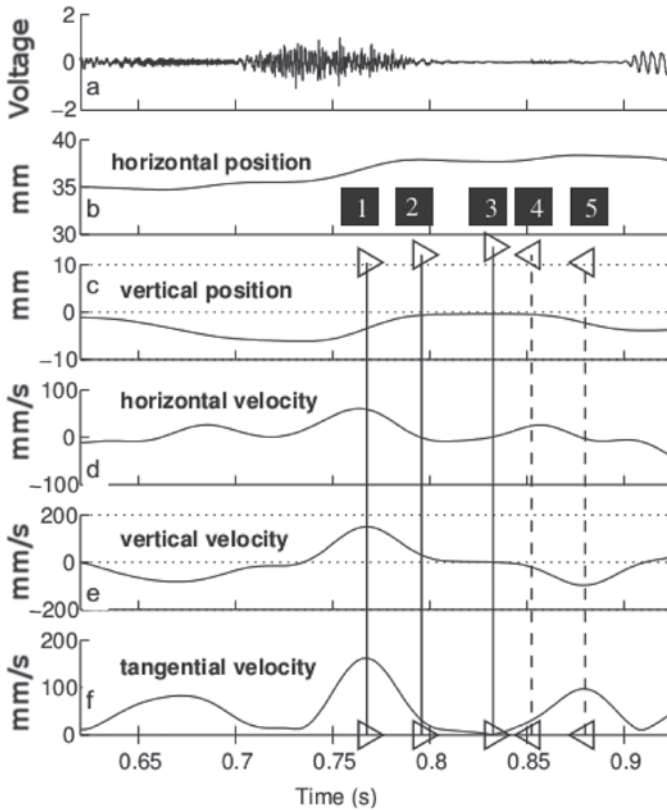

Fig. 5: Articulatory segmentation with *mtnew*. Panels from top to bottom: (a) acoustic signal, (b) anterior-posterior tongue back movement, (c) longitudinal tongue back movement, (d) horizontal velocity, (e) vertical velocity, (f) tangential velocity. Measurement points (vertical bars) from left to right: (1) peak velocity during upward movement, (2) 20% threshold (plateau onset), (3) minimum velocity, (4) 20% threshold (plateau offset), (5) negative peak velocity during downward movement.

horizontal velocity, (e) the vertical velocity, and (f) the tangential velocity. The aim of the segmentation was to determine the plateau onset and offset of an articulatory gesture. In the figure these points can be seen in (c). The tongue moves up to form the closure (from about 0.75 to about 0.77 seconds on the abscissa), it stays there until about 0.86 (this is the ‘plateau’), and then it is lowered again.

Plateau onset and offset (measurement points 2 and 4, respectively) were measured as 20% threshold points on the vertical velocity signal. In order to measure a gesture, two cursors are placed around the articulatory gesture. The program then searches for a positive and a negative peak on the velocity signal in the interval between the cursors (measurement points 1 and 5 in the figure). Then it looks for the minimum in between the two peaks (measurement point 3). It calculates the difference between each peak and the minimum. The plateau onset of a gesture is defined as the point towards the left of the minimum where the velocity drops below 20% of the positive peak velocity. Plateau offset is defined as the point where the velocity exceeds 20% of the negative peak velocity. Plateau measurements are generally carried out on the vertical velocity signal, except for the lip aperture gestures, which are measured on the velocity derived from the lip aperture.

2.5 Acoustic segmentation

Acoustic labeling proceeded in two stages: at the first stage, an automatic segmentation was generated via the forced alignment tool MAUS (Beringer and Schiel 1999; Schiel 2004; Schiel et al. 2011). The second stage involved the manual correction of these automatically derived labels. The first stage – automatic segmentation – consisted of two steps. In the first step, the orthographic representation of the stimuli was extracted from log files automatically generated during experimental sessions. These orthographic transcriptions were in the next step converted into a canonical SAMPA transcription that was stored to disk along with the orthographic transcription. This conversion from orthography to transcription was carried out using the balloon tool (Reichel 2012). The second step consisted of applying the MAUS tool to the data using the previously generated orthographic and SAMPA transcriptions along with the audio files as input. This resulted in preliminary PRAAT (Boersma and Weenink 2012) text grids.

In the second stage, these text grids were edited manually. For the present analysis, only the labels for vowel onset and offset are used. Vowel onset was measured as the beginning of the vowel’s formant structure if it followed a voiced sound. The end of the vowel was measured as the end of the vowel’s formant structure.

2.6 Stability analysis

For the stability analysis, three interval durations were calculated. The anchor point in the intervals below was defined as the plateau onset of the anchor consonant:

- Left edge to anchor (LE2A): the interval from the plateau onset of the initial consonant to the anchor.
- Right edge to anchor (RE2A): the interval from the plateau offset of the prevocalic consonant to the anchor.
- C-center to anchor (CC2A): the interval from the C-center to the anchor. The C-center was calculated as the mean over all consonantal plateau midpoints.

In order to estimate the stability of these intervals, standard deviations were calculated across pairs of items which differed in onset complexity but not in the vowel and were produced in the same accentuation condition and by the same speaker (e.g., *plagen-lagen* produced by Speaker 1, accentuated condition).

From these standard deviations, relativized standard deviations (RSDs) were gained by calculating coefficients of variation in order to account for the fact that standard deviations of time intervals are correlated with their mean values (Bortz 1999). Since the number of repetitions varied across the corpus due to technical and segmentation problems, we used the formula given in Sokal and Braumann (1980) that accounts for the number of repetitions. Following this formula, the standard deviation was divided by the mean and this term was then multiplied by $(1 + 1/4n)$, with n being the number of repetitions.

2.7 Vowel compression analysis

A C-center effect can emerge when the prevocalic consonant in a CCV sequence overlaps more with the vowel than the singleton consonant in a CV sequence. Phonetically, this should be measurable as a shortening or compression of the vowel in a CCV sequence compared to a CV sequence. Vowel duration was measured as the right edge to anchor interval. Vowel compression was calculated as the difference between the vowel duration in the CV sequence and the vowel duration in the CCV sequence.

The right edge to anchor interval can be regarded as only a rough approximation to the articulatory vowel duration, but it seems to be a better approximation than intervals defined by landmarks on the vowel-related movement of the tongue. Landmarks on the vowel-related movement of, for example, the tongue mid sensor are highly dependent on the identity of the vowel, but also on the

consonantal surroundings. In order to be able to make more general claims for onset-nucleus timing relations, which are independent of vowel identity and consonantal surroundings, we decided to measure the articulatory vowel duration as the right edge to anchor interval.

2.8 C1-C2 lag analysis ('overlap analysis')

Overlap between two consonantal plateaus of a cluster was measured as the difference between the onset of the prevocalic consonant and the offset of the initial consonant. If this value is positive, there is a lag between the two consonantal plateaus; if it is negative, there is overlap.

2.9 Coarticulation analysis

Previous research suggests that there is a relation between vowel compression as measured in vowel compression analyses and the movement amplitude of the tongue movement from the prevocalic consonant to the vowel (cf. Section 1.3). Thus, the C-center effect could simply be the result of the larger CV movement in a CV item as compared to a CCV item.

In order to test this hypothesis, the movement amplitude of the CV movement was calculated. First, the beginning and end of the vowel in the acoustic signal were labelled. An acoustic target of the vowel was determined as the midpoint (for monophthongs) or the point at one-third of the duration (for diphthongs). The amplitude of the CV movement of the tongue mid sensor, which is most representative of a movement towards the vowel, was estimated as the Euclidean distance between the position of this sensor at plateau onset of the prevocalic consonant and the vowel target. A mean Euclidean distance for all repetitions of an item was calculated. Afterwards, the difference between the Euclidean distances of a singleton item and the corresponding cluster item was calculated. This difference will be called ED_{diff} .

To give an example, for the pair *queren-wehren*, first the Euclidean distance from the tongue position in cluster /v/ to the tongue position during the vowel was calculated. Then the Euclidean distance from the tongue position in singleton /v/ to the tongue position at the vowel target was calculated. Afterwards, a mean across the EDs of all repetitions of *queren* by a speaker and a mean across the EDs of all repetitions of *wehren* were calculated. Finally, the difference between the two means was calculated. If the resulting value ED_{diff} is positive, the tongue has moved farther in the singleton than in the cluster. If ED_{diff} is negative, the tongue has moved more in the cluster.

Afterwards, a correlation between the movement amplitude difference (ED_{diff}) and the vowel compression values (cf. Section 2.7) was calculated.

2.10 Statistics

The data analyzed in this study are unbalanced, mainly because not every cluster was recorded for every speaker. Repeated measures ANOVAs could therefore not be used to test our hypotheses. Instead, linear mixed models were used (Pinheiro and Bates 2000). A potential problem with linear mixed models is the calculation of p -values since at present it is unclear how to calculate the degrees of freedom for t and F -tests. Following Baayen (2011), the p -values in this study were calculated using Markov chain Monte Carlo sampling. All statistical analyses (see above) were carried out in R (R Development Core Team 2008).

In the linear mixed models, the variable Speaker was entered as a random factor. Best linear unbiased predictors of this random effect were extracted and found to be normally distributed (Pinheiro and Bates 2000, Section 4.3.2). The effects we find are thus independent of single speakers.

3 Results

This section consists of three parts. The first two give results of the stability analysis and the vowel compression analysis. The final section discusses the influence of the phonetic mechanisms listed in the Introduction.

All the results are pooled across sentence accent conditions because Accentuation, which was a fixed effect in the linear mixed models, was not significant. The main reason for that is that subjects did not produce the stress patterns as we expected. Whereas in the stressed condition, the stress was always on the target word (as expected), in the unstressed condition, speakers placed the stress on the target word as well after a couple of sentences, simply because the target word was the new information.

3.1 Stability analysis

Table 2 gives mean RSD (relative standard deviations) values over speakers and conditions. Minimal RSDs are in bold print. According to the C-center hypothesis, in syllable onsets, the C-center to anchor interval in CCV and CV sequences should be less variable than either the RE to anchor interval or LE to anchor

Table 2: Mean RSDs (multiplied by 100) over speakers and accentuation conditions (i.e., each number is a mean over $s \times 2$ RSDs with s = number of speakers and 2 = number of accentuation conditions). Minimal RSDs are in bold.

Condition	Items	Cluster	Vowel	RSD LE	RSD RE	RSD CC	
initial	<i>glänzen - Lenze</i>	gl	lax	19	15	13	
	<i>glauben - Lauben</i>	gl	diph	17	15	14	
	<i>gleiten - leiten</i>	gl	diph	18	8	11	
	<i>Plätze - Lätze</i>	pl	lax	27	14	19	
	<i>plagen - lagen</i>	pl	tense	23	10	16	
	<i>plauschen - lauschen</i>	pl	diph	22	10	15	
	<i>Sketche - Ketchup</i>	sk	lax	16	19	11	
	<i>Skat - Kater</i>	sk	tense	15	9	8	
	<i>skypen - Keime</i>	sk	diph	11	19	13	
	<i>Quelle - Welle</i>	kv	lax	34	15	20	
	<i>queren - wehren</i>	kv	tense	32	18	21	
	<i>queilen - weilen</i>	kv	diph	26	13	14	
	medial	<i>geglänzt - gelenzt</i>	gl	lax	18	13	12
		<i>geglaubt - belaubt</i>	gl	diph	17	18	16
		<i>begleiten verleiten</i>	gl	diph	18	11	12
<i>geplättet - verletzt</i>		pl	lax	30	15	19	
<i>geplagt - Gelage</i>		pl	tense	18	17	10	
<i>geplauscht - gelauscht</i>		pl	diph	18	12	12	
<i>gesketcht - gecatcht</i>		sk	lax	17	22	12	
<i>geskatet - verkatert</i>		sk	tense	16	11	7	
<i>geskyped - gekeimt</i>		sk	diph	15	20	12	
<i>gequellt - gewellt</i>		kv	lax	26	16	17	
<i>gequert - gewehrt</i>		kv	tense	45	34	33	
<i>verqueilen - verweilen</i>		kv	diph	25	14	14	
word boundary		<i>knapp Lätze - Lätze</i>	pl	lax	24	13	18
		<i>knapp lagen - lagen</i>	pl	tense	16	13	12
		<i>knapp lauschen - lauschen</i>	pl	diph	18	9	13
	<i>lass Ketchup - Ketchup</i>	sk	lax	15	15	11	
	<i>lass Kater - Kater</i>	sk	tense	11	9	8	
	<i>lass Keime - Keime</i>	sk	diph	14	12	11	
	<i>pack Welle - Welle</i>	kv	lax	30	14	19	
	<i>pack wehren - wehren</i>	kv	tense	26	20	18	
	<i>pack weilen - weilen</i>	kv	diph	19	11	12	

interval. Across a word boundary, the RE to anchor interval should be most stable. So the bold numbers should be predominantly in the rightmost column for initial and medial clusters. For the word boundary clusters, the right edge RSDs should be lowest, so the bold numbers should be in the RSD RE column for those clusters. The data do not fully support the C-center hypothesis. The following observations can be made:

- Across cluster positions (initial, medial, word boundary), there is a strong dependency of the stability pattern on the cluster. If the cluster is /gl/ or /sk/, the C-center RSD tends to be lowest, in line with the C-center hypothesis. For the clusters /pl/ and /kv/, however, the right edge RSD tends to be lowest.
- C-center stability occurs somewhat more often in medial than in initial and word boundary clusters.
- Across cluster positions, there are arguably more cases with C-center stability (i.e., where the C-center RSD is lowest) if the item pair contains tense vowels (six cases) than if it contains lax vowels or diphthongs (five cases each).
- There is no tendency for the word boundary clusters to exhibit right-edge stability, or at least this tendency is not more pronounced than in the initial or medial clusters.
- The item pairs that were problematic in terms of the syllable affiliation of the anchor consonant do not show a special behaviour. There is C-center stability in *Skat-Kater* (but also in the comparable item pair *Sketche-Ketchup*). There is also C-center stability in *geplagt-Gelage* (but also in the comparable item pair *geplauscht-gelauscht*).

For the subsequent statistical analysis, the LE RSDs were ignored since LE stability, as can be judged from Table 2, is very rare. The data were grouped according to the hypothesized phonological parse, i.e., the data for the initial and medial clusters were classified as *complex* onset parse, and word boundary data as *simplex* onset parse, since in word boundary clusters only the prevocalic consonant belonged to the syllable under investigation. One statistical model was fitted to investigate the influence of parse on the C-center RSDs, and a second one was fitted to investigate the influence of parse on the right-edge RSDs. Following the C-center hypothesis, parse should have a significant influence in both models: C-center RSDs should be lower in initial and medial clusters ('complex onset parse') than in word-boundary clusters ('simplex onset parse'), and right-edge RSDs should be lower in word boundary clusters than in initial and medial clusters.

A linear mixed model was calculated with C-center RSD as dependent variable; Parse, Cluster, Vowel, and Accentuation as fixed effects; and Subject as random effect. The results suggest that Parse and Accentuation had no significant

effect, whereas Cluster and Vowel did have an effect on the C-center RSDs. Whether a cluster occurs initially/medially or across a word boundary thus does not have an influence on the variability of the C-center to anchor interval, although segmental properties such as the cluster identity do have an influence.

Independently of the parse (i.e., initial/medial vs. word boundary), /kv/ had the highest C-center RSDs, followed by, in this order, /pl/, /gl/, and /sk/. The cluster /kv/ differed significantly from /pl/ ($pMCMC = .001$), from /gl/ ($pMCMC = .000$), and from /sk/ ($pMCMC = .000$). /pl/ furthermore differed significantly from /gl/ ($pMCMC = .017$) and /sk/ ($pMCMC = .000$). /gl/ did not differ significantly from /sk/. The C-center RSDs of lax vowels were significantly higher than those of tense vowels ($pMCMC = .027$) and diphthongs ($pMCMC = .007$).

A similar linear mixed model was calculated for the right-edge RSDs. In this model the variable Parse had a significant effect ($pMCMC = .004$); however, the effect was not in the direction predicted by the C-center hypothesis. The complex onset right-edge RSDs were lower than the simplex onset right-edge RSDs. The variables Cluster and Vowel had a significant influence as well. /kv/ had the largest right-edge RSDs, followed by /sk/, /pl/, and /gl/. /kv/ differed significantly from /pl/ ($pMCMC = .003$) and from /gl/ ($pMCMC = .010$). /sk/ differed significantly from /pl/ ($pMCMC = .019$). Lax vowels had lower right-edge RSDs than diphthongs ($pMCMC = .026$). Accentuation was not significant.

Even if some of the item pairs favor a C-center effect (*Skat-Kater*, *geplagt-Gelage*), the results of the stability analysis are not in agreement with the C-center hypothesis. Although German, as a language that admits complex onsets, should exhibit C-center stability in initial and medial clusters, this pattern was not generally observed. Rather, the timing patterns were highly dependent on the properties of the segments that make up the CCV and CV sequences. If the cluster was /gl/ or /sk/, C-center stability was observed more often than if it was /pl/ or /kv/. If the vowel was lax, C-center stability was observed less often than if it was tense or a diphthong. If the singleton or cluster occurred medially, C-center stability was observed more often than if it occurred initially.

3.2 Vowel compression analysis

Figure 6 shows vowel compression from CV to CCV sequences. Positive values indicate that the CCV vowel is shorter than the CV vowel. Each bar shows means over repetitions, speakers, and accentuation conditions. The rows correspond to different vowel types, the columns to different cluster positions. According to the C-center hypothesis, the CCV vowel should be shorter than the CV vowel in initial and medial position but not in word boundary clusters. There are a couple of

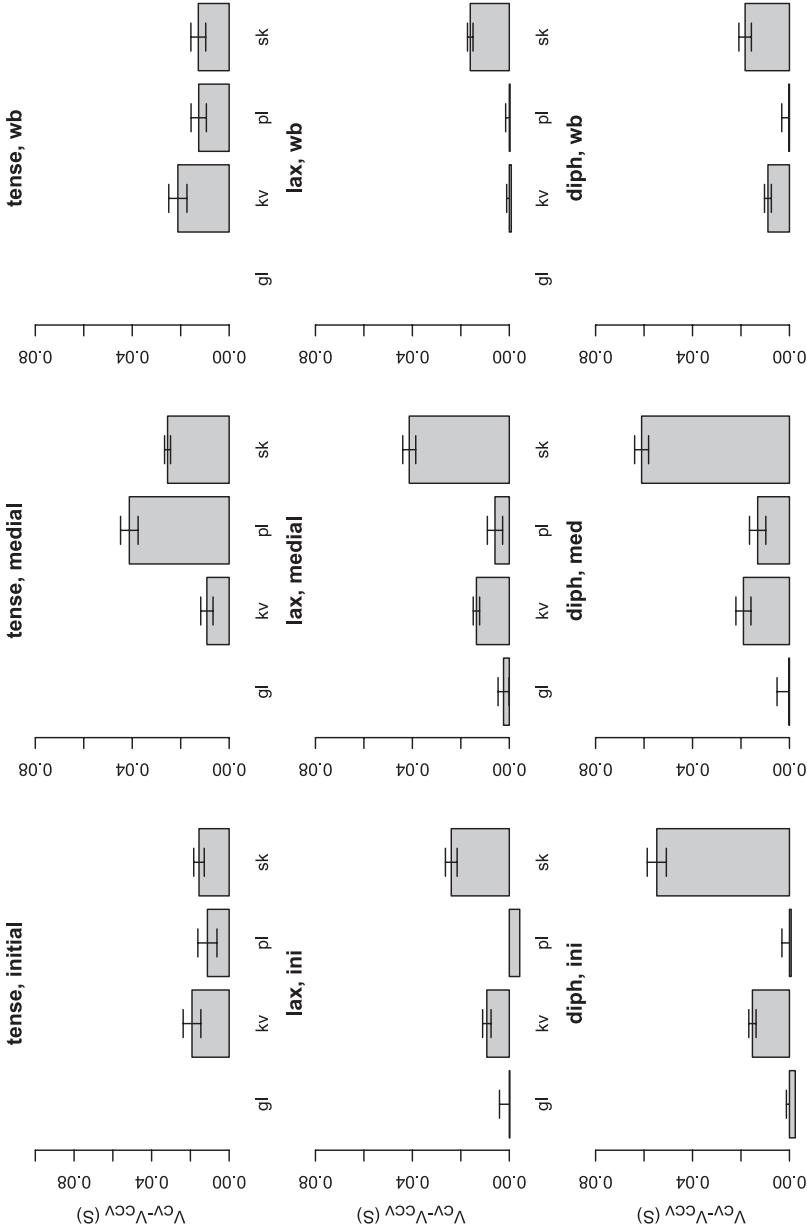

Fig. 6: Vowel duration differences in seconds (vowel compression from CV to CCV, ordinate) for items with tense vowels (top row), lax vowels (middle row), and diphthongs (bottom row) and different cluster positions (columns). Positive values mean that the vowel in the CCV sequence is shorter than the vowel in the CV sequence.

instances where this can be seen. The vowel following /sk/ shortened more in medial clusters than in word boundary clusters. However, for /sk/, the tense vowels shortened similarly in word boundary clusters and in initial clusters. For the pair *Skat-Kater*, one could actually expect more shortening simply because vowels have a tendency to lengthen in an open vowel (cf. *Kater*). This was not observed. The highest values for vowel compression were found for the initial/diphthong and the medial/diphthong condition (*skypen-Keime* and *geskyped-gekeimt*). These values are in part the result of the different anchor since vowels tend to lengthen before voiced segments. The vowel following /pl/ shortened more in medial tense clusters than in word boundary clusters. This can be explained by the different syllable affiliation of the anchor in *geplagt-Gelage*. The different anchor consonant in *geplättet-verletzen* (medial/lax) did not seem to play a role. However, for lax medial vowel items, this effect was less pronounced, and the effect was reversed when comparing lax vowels following initial /pl/ to word boundary /pl/. For /kv/ there was a small effect for lax vowel and diphthong items but not for tense vowel items.

As in the stability analysis, the cluster clearly has more influence on vowel compression than the cluster position (initial vs. medial vs. word boundary). Vowel compression from CV to CCV was found most of the time for /sk/ and /kv/, but usually not for /gl/ and /pl/. Vowel compression was more pronounced for longer vowels (tense vowels and diphthongs) than for short lax vowels. The analysis shows again that segmental properties seem to be influential in shaping gestural timing in clusters.

A linear mixed model was calculated with Vowel Compression, Position, Vowel Type, Cluster, and Accentuation as fixed effects and Speaker as random effect. In medial position, the vowel compression was slightly larger (9 ms) than in initial position ($p\text{MCMC} = .000$), and in word boundary position, there was less vowel compression than in initial position ($p\text{MCMC} = .034$) and medial position ($p\text{MCMC} = .000$). There was a significant difference between the tense and the lax vowels with lax vowels having less vowel compression ($p\text{MCMC} = .005$), and between lax vowels and diphthongs with lax vowels having less vowel compression ($p\text{MCMC} = .021$). The difference between tense vowels and diphthongs was not significant. The differences between the clusters were all highly significant ($p\text{MCMC} < .001$), except for the difference between /kv/ and /pl/, which was insignificant. /sk/ had the largest values, followed by /kv/, /pl/, and /gl/. Accentuation had no significant influence.

There is thus an influence of position as predicted by the C-center hypothesis: there is more vowel compression when there is no word boundary than when there is one. However, looking at the estimates of the model, one can see that the influence of the cluster is larger. Whereas in word boundary position, for exam-

ple, the shift is 6 ms smaller than in initial position and 15 ms smaller than in medial position, the difference between, for example, /pl/ and /sk/ is 20 ms, and the one between /sk/ and /gl/ is 35 ms. The estimates of the different vowel classes are comparable in magnitude with the ones for the different cluster positions.

3.3 Influence of segmental properties

3.3.1 Consonant-consonant-transition: C1-C2 lag analysis

Figure 7 shows the results of the C1-C2 lag analysis. Positive values mean that there is a lag between the two plateaus. Consonantal overlap is very rare; it exists in some productions but cannot be seen in the means presented in the figure. The figure shows lags for each cluster (bars correspond to means over speakers, repetitions, and accentuation conditions) in each vowel condition (rows) and each position condition (columns).

Judging from the figure, the most influential parameter is the cluster. The lags are largest for /kv/, smaller but still large for /pl/, and small for /sk/ and /gl/. The second most influential parameter seems to be the position. When a word boundary is in between the two consonants, the lag duration of /kv/ and /pl/ is dramatically reduced. Differences between initial and medial clusters are inconsistent. The vowel type (tense vs. lax vs. diphthongs) does not have a consistent influence either.

A linear mixed effects model was fitted with C1-C2 Lag Duration, Position, Vowel, Cluster, and Accentuation as fixed effects and Speaker as random effect. The model confirmed the observations shown in Figure 7. In the word boundary condition, the lag duration was significantly shorter than in either initial or medial position ($pMCMC = .000$). The difference between initial and medial position was not significant. Before lax vowels the lag duration was significantly shorter than before tense vowels ($pMCMC = .005$), and before tense vowels it was significantly longer than before diphthongs ($pMCMC = .006$). The greatest influence came from the cluster. All clusters differed highly significantly ($pMCMC = .000$), except for the /gl/-/sk/ contrast ($pMCMC = .012$). /kv/ had the largest lags, followed by /pl/, /gl/, and /sk/. Accentuation was not significant.

In line with Pouplier (2012), there seems to be a relationship between lag duration and C-center RSDs. Items that have been shown to have a clear C-center effect in the stability analysis have a small lag (/sk/, /gl/). In contrast to that, items with a large lag (/kv/ and /pl/) have been shown to have no C-center effect. Data were split according to vowel type (tense vs. lax vs. diphthong), and Spearman correlations were calculated. They show that for all vowel classes, the greater

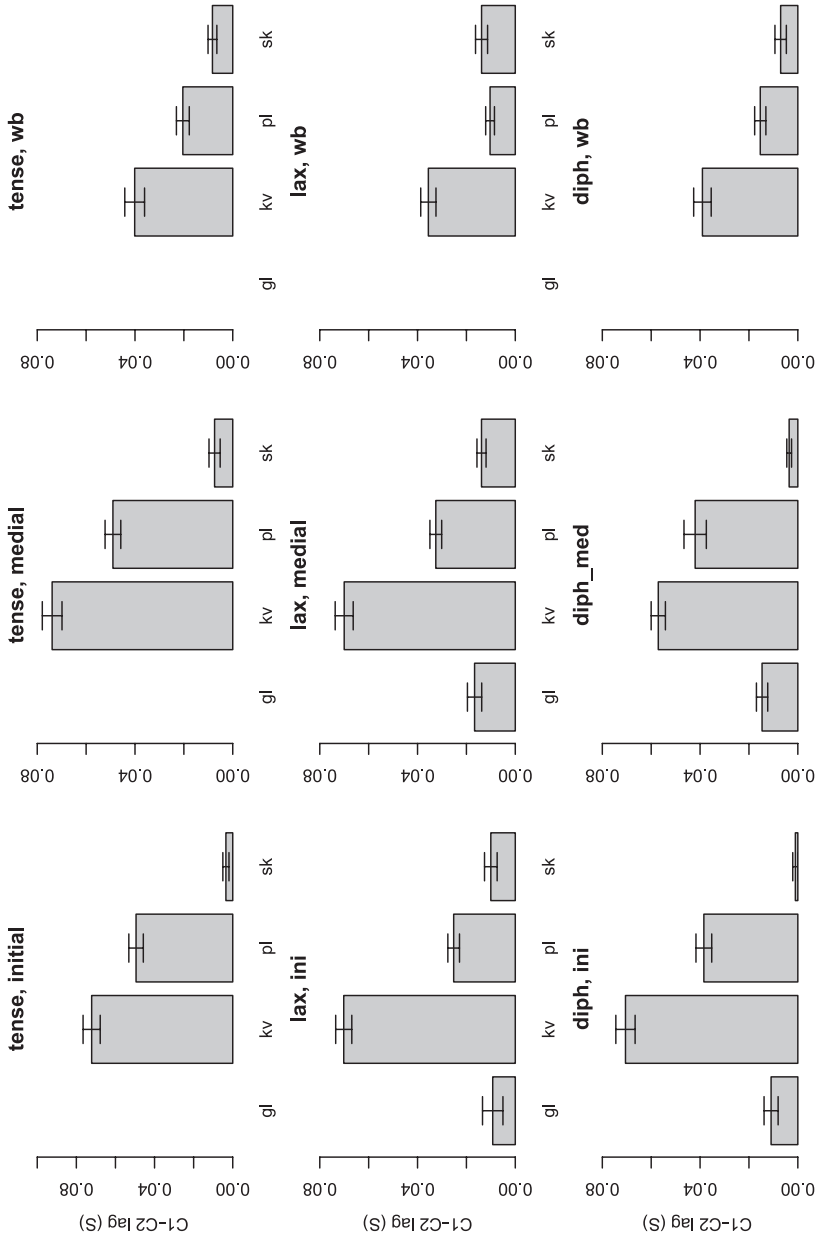

Fig. 7: C1-C2 lag duration in seconds (ordinate) for items with tense vowels (top row), lax vowels (middle row), and diphthongs (bottom row) and different cluster positions (columns).

the lag, the larger the C-center RSDs. This relationship is clearer for the monophthongs than for the diphthongs (tense vowels: Spearman's $\rho = 0.522$, $p = .000$; lax vowels: $\rho = 0.430$, $p = .000$; diphthongs: $\rho = .208$, $p = .024$). An explanation for the observed relation is that the lag between the two consonants shifts the initial consonant away from the C-center, which reduces C-center stability.

3.3.2 Consonant-vowel transition: Oral-laryngeal coordination

As indicated in the introduction, some singleton and cluster consonants differ in their oral-laryngeal coordination. A singleton /k/ is usually aspirated whereas /k/ in the cluster /sk/ is not. The reason for this is that in German sibilant-stop clusters, there is just one glottal opening gesture with its peak in the middle of the cluster (e.g., Hoole 2006). In a German voiceless singleton stop, the burst occurs well before the glottal closing gesture finishes, roughly coinciding with peak glottal opening. In fricative-stop clusters, peak glottal opening takes place towards the middle or the end of the fricative, and the glottis is closed at the time when the stop burst occurs.

Figure 8 shows an example. The figure shows the vertical component of the sensor movements during productions of *skypen* (a) and *Keime* (b) by Speaker 6, accentuated condition. In each subplot the movements in the upper half are consonantal movements and the movements in the lower half are vocalic movements. The movements are aligned at the consonantal anchor, which is shown by a vertical solid line in the right of the figure.

In Figure 8a, one can see the tongue tip movement of /s/ (black solid curves), the tongue back movement of /k/ (grey solid curves), and the lip aperture of /p/ (dotted curves). In Figure 8b, the movement of the tongue mid producing the vowel is shown (thick black curves), and the corresponding movements for *Keime* are shown.

Additionally, the approximate point of aspiration offset is marked (vertical dashed line in the middle of both subplots). In *skypen*, where there is no aspiration, this point coincides with the plateau offset. In *Keime* there is an aspiration phase of 60 ms which starts at plateau offset (dash-dotted line). One can see that at the point of aspiration offset (dotted vertical line), the tongue is lower in *Keime* than in *skypen* because the entire velar gesture is shifted towards the left in *Keime*. This is in line with earlier findings. Jessen (1999), for example, presents data showing that in CV productions where V is a low vowel, F1 is higher after an aspirated C than after an unaspirated C because the vocal tract is opened more widely at the end of the aspiration than at the end of the consonantal plateau.

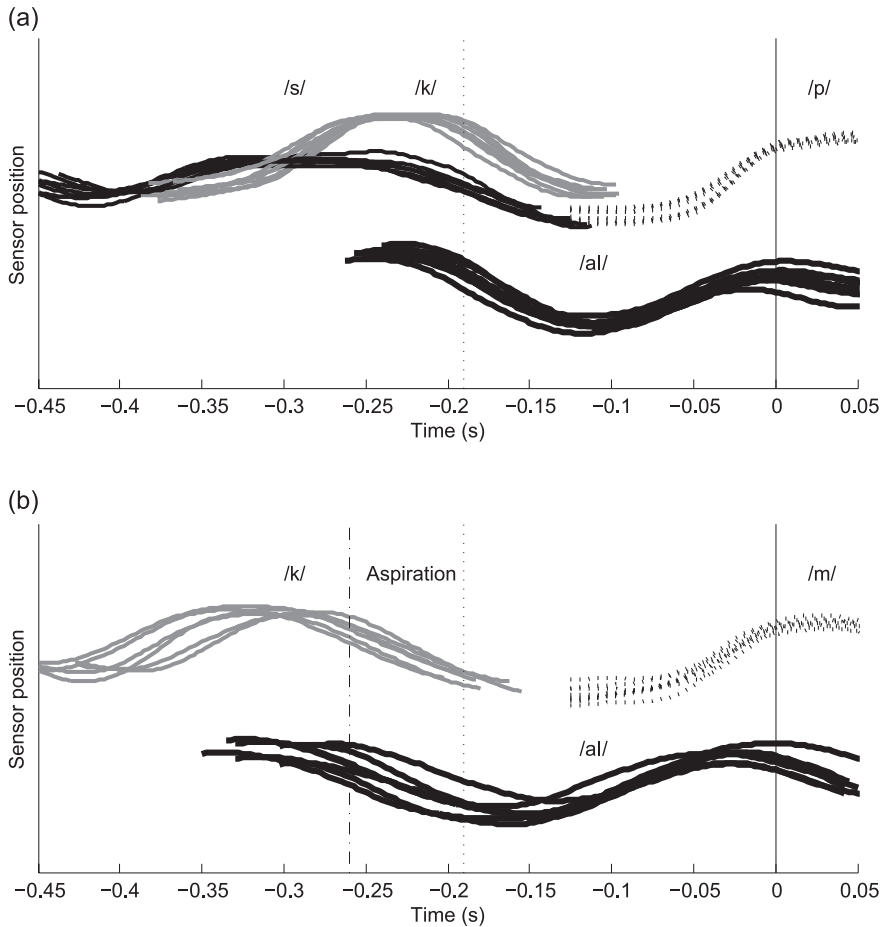

Fig. 8: (a) Articulatory movements in *skypen*, Speaker 6, accentuated condition. Thin black curves: tongue tip movement in /s/; grey curves: tongue back movement in /k/; dotted curves: lip aperture in /p/; thick black lines: tongue mid sensor movement in /a/. (b) Grey curves: tongue back movement in /k/; dotted curves: lip aperture in /m/; black curves: tongue mid sensor movement in /a/. Vertical lines: dash-dotted: approximate closure offset in Keime; dotted: aspiration offset; solid: anchor.

Superficially, the timing pattern of *skypen* and *Keime* looks like a typical instance of C-center stability, and the measurements presented in Sections 3.1 and 3.2 support this: singleton /k/ is farther away from the anchor than cluster /k/. However, there is another observation that casts doubt on this explanation. The C-center effect can only be observed on measurements of *lingual* movements. If

/k/ is measured on the glottalic opening and closing movement, the C-center effect disappears.

In order to approximate the timing of glottal movements, vowel duration was measured acoustically. During the aspiration phase, the glottis is open and there is no periodic signal. As soon as the glottis is closed, the vocal folds start vibrating, which results in a periodic signal. The onset of the periodic signal is thus the offset of the glottal /k/-related movement and the onset of the acoustic vowel. The end of the vowel was measured as F2 offset.

The acoustic vowel durations were used to carry out a second vowel compression analysis, similar to the one presented in Figure 6. Figure 9 shows the results. Positive values indicate that the vowel in the CCV item was shorter than the one in the CV item. There are high negative bars for /sk/, meaning that the CCV vowel was often longer than the CV vowel. This is in sharp contrast to the results from the articulatory vowel compression analysis (cf. Figure 6), where the CCV vowel was usually shorter than the CV vowel. This difference between articulatory and acoustic measurements cannot be observed for the other clusters, which have no difference in oral-laryngeal timing between singleton and cluster consonants; it is unique for /sk/, which has such a difference.

Importantly, the shift reversal in articulatory as compared to acoustic data found for initial and medial clusters cannot be observed in the word boundary clusters. This is because these clusters do not have a difference in oral-laryngeal timing between singleton and cluster consonants, either. In word boundary clusters, there are two glottal opening-closing gestures, resulting in an aspirated /k/ in the /s#k/ cluster, which has the same oral-laryngeal timing as singleton /k/.

The data presented in this section show that the only clear instance of a C-center effect in the present study (i.e., the /sk/ cluster) emerges out of a difference in oral-laryngeal timing: an aspirated stop (singleton /k/) is compared to a non-aspirated stop (cluster /k/). The C-center effect observed here is thus linked to a phonetic property of the segments making up the cluster.

3.3.3 Consonant-vowel transition: Coarticulation

As mentioned in the introduction, according to Recasens' degree of articulatory constraint (DAC) model (e.g., Recasens et al. 1997), sounds with a high "degree of involvement of the tongue dorsum in closure or constriction formation" (544), such as /s, ʃ, k/, exert much influence on the surrounding vowels and are themselves rather resistant to the influences of surrounding sounds. They have high coarticulatory resistance and at the same time high coarticulatory aggressiveness.

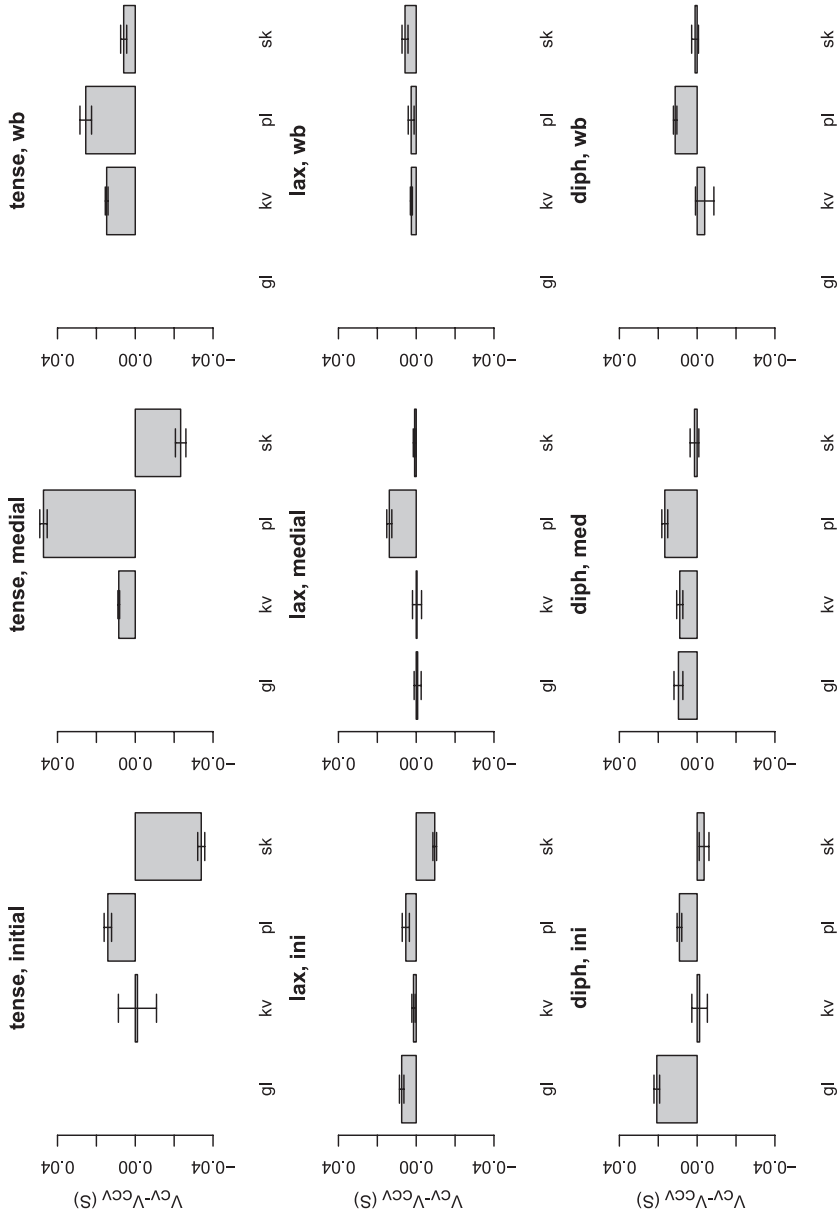

Fig. 9: Vowel compression for acoustically labelled vowels for items with tense vowels (top row), lax vowels (middle row), and diphthongs (bottom row) and different cluster positions (columns).

Earlier work (Lehiste 1970) furthermore suggests that coarticulation might have an influence on gestural timing. In a sequence such as /gεg/, for example, the vowel is influenced by the preceding /g/, and the movement from /ε/ to the following /g/ is likely to be shorter and to take less time than in a sequence such as /tεg/, where the vowel is less /g/-like.

The clusters investigated in this study consist of sounds which differ in coarticulatory resistance and aggressiveness. In /kv/, for example, there is a sound with very high coarticulatory resistance and aggressiveness (/k/), which is followed by a sound with very little resistance and aggressiveness. /k/ should thus exert much influence on /v/, so that cluster /v/ should clearly differ from singleton /v/ because singleton /v/ is not influenced by /k/ but rather by the preceding /a/.

Figure 10a shows interpolations between the positions of the tongue tip, tongue mid, and tongue back sensors at lower lip target achievement of /v/ in *queren* and *wehren* for three speakers. The black contours correspond to cluster /v/, the grey contours to singleton /v/. The tongue positions differ for the two

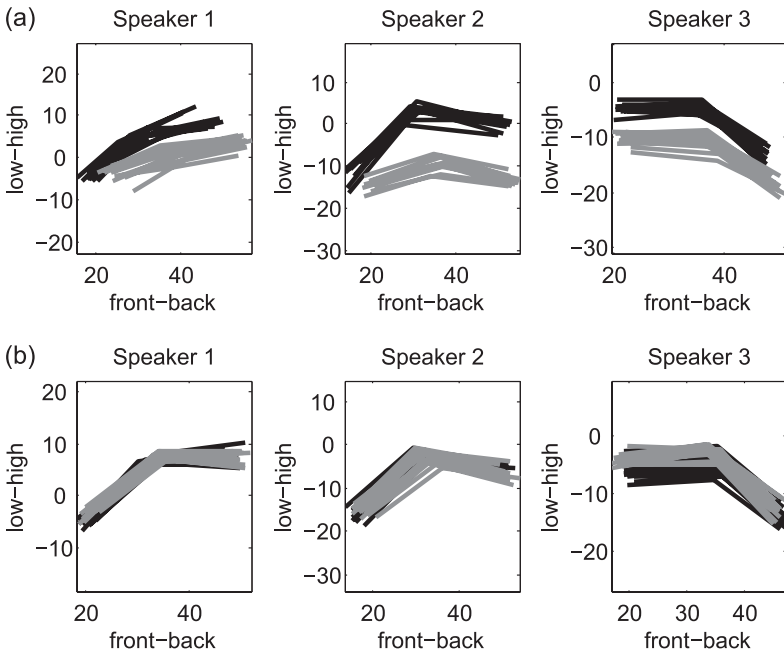

Fig. 10: (a) Position of tongue sensors at plateau onset of /v/ during *queren* (black) and *wehren* (grey). Front is left. (b) Position of tongue sensors during the vowel following /v/ in *queren* (black) and *wehren* (grey).

conditions. Whereas the tongue is high during cluster /v/, it is lower and flatter in singleton /v/.

Figure 10b shows tongue positions at the midpoint of the acoustically measured vowel /e/ following /v/. Those tongue positions are very similar for the singleton and the cluster item. More importantly, however, comparing the absolute positions, it becomes clear that the tongue has to travel farther from the singleton /v/ to /e/ than from the cluster /v/ to /e/. This influences the segment duration: in *wehren* the vowel increases in length relative to its length in *queren* because more time is needed to take the tongue from the low /v/ position to the /e/ position than from the high /v/ position to the /e/ position. The shift towards the vowel observed for *queren-wehren* in the vowel compression analysis, which in previous analyses was interpreted as the result of a complex onset parse, might thus be the result of a larger transitional movement from /v/ to /e/ in *wehren* as compared to *queren*.

Before coming to a generalization, a second example will be discussed. In /pl/ there were few instances of shift of the prevocalic consonant towards the vowel. In terms of coarticulation, /pl/ differs from /kv/ because the prevocalic consonant /l/ is a segment with moderate coarticulatory resistance and aggressiveness and is preceded by a sound with low resistance and aggressiveness (/p/). As a result, singleton and cluster /l/ in items such as *Plätze* and *Lätze* should be similar. Figure 11 shows tongue contours for three speakers. As expected, the tongue contours of singleton and cluster /l/ are more similar than the ones in /v/. The positions of the tongue sensors are more or less identical. Moreover, in contrast to /kv/, where the tongue had to move more to come from singleton /v/ to the vowel than from cluster /v/ to the vowel, the tongue has to move more to come from cluster /l/ to the vowel in the example with the lateral for Speakers 2 and 3. Thus, the CV movement in *Plätze* should take even longer than the CV movement in *Lätze*, resulting in negative vowel compression, which is actually observed for this item pair (cf. Figure 6).

These two examples suggest that, in line with what was suggested by Lehiste (1970) for VC movements, there is a relation between vowel compression and the movement amplitude of the tongue from the prevocalic consonant to the vowel.

In order to test this hypothesis, ED_{diff} , the difference in CV-movement amplitude between the CCV and the CV items, was correlated with the vowel compression values shown in Figure 6. The correlation between the two parameters was positive and significant ($r = .383$, $p = .000$), meaning that if there is vowel compression from CV to CCV, then there is also a larger movement of the tongue from the singleton consonant to the vowel than from the prevocalic consonant to the vowel.

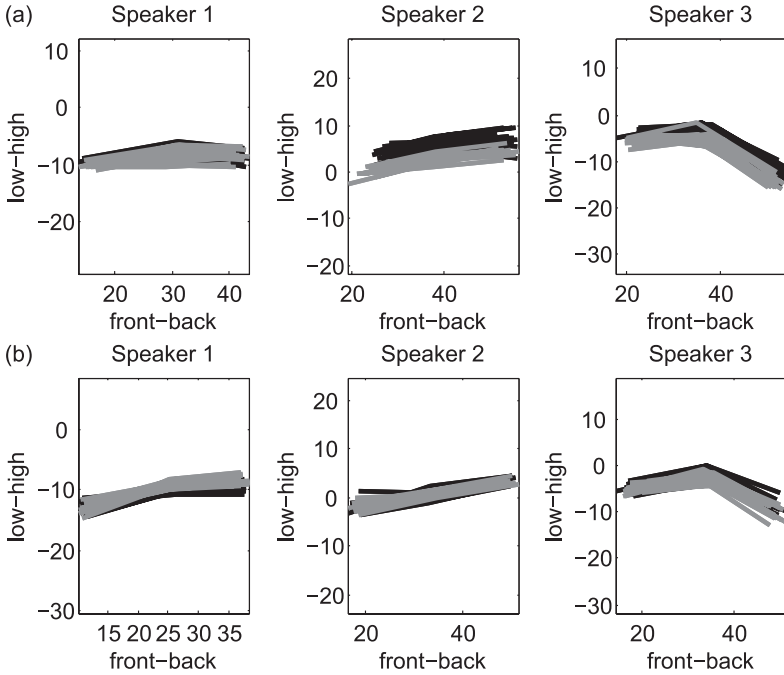

Fig. 11: (a) Position of tongue sensors at plateau onset of /l/ during *Plätze* (black) and *Lätze* (grey). Front is left. (b) Position of tongue sensors during the vowel following /l/.

Figure 12 shows ED_{diff} on the abscissa and vowel compression on the ordinate. The upper left subfigure shows data points for all three clusters in different greys. The other subfigures show the data points of a single cluster only. Bold fonts correspond to initial clusters, bold italics to medial clusters, and pure italics to word boundary clusters.

Looking at the upper-right subplot of Figure 12, one can observe that the data points for /gl/ are concentrated in the left half of the figure, meaning that the CV movement is longer in the cluster than in the singleton item. These items tend to have vowel compression values of around zero, so no C-center effect is observed in the vowel compression analysis. The light grey data points for /kv/ tend to be in the middle of the figure. In those item pairs, the CV movement in the singleton is larger than in the cluster item. The vowel compression values are mostly positive, resulting in a C-center effect in the vowel compression analysis. The black /pl/-data points spread from the middle towards the right of the figure, meaning that the movement amplitudes in CCV and CV sequences are sometimes the same

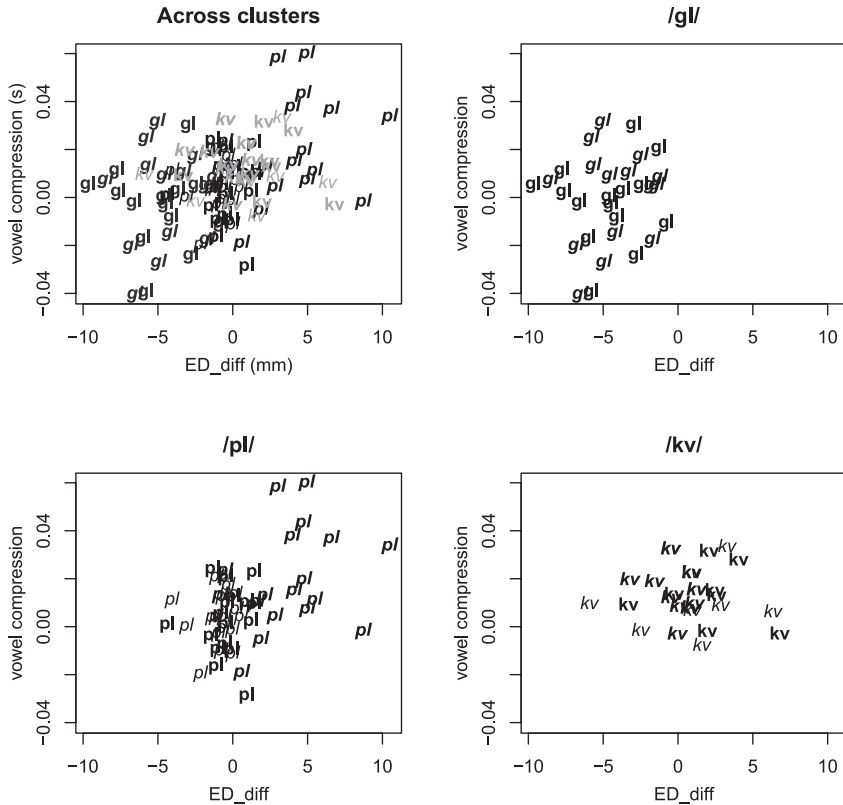

Fig. 12: ED_{diff} (abscissa) versus vowel compression (ordinate). Bold: initial clusters; bold italics: medial clusters; italics: word boundary clusters. High ED_{diff} values: larger CV movement in the singleton item; low ED_{diff} values: larger CV movement in the cluster item. High compression values: CCV vowel is shorter than the CV vowel.

but sometimes larger in the CV item than in the CCV item. The compression values of /pl/ tend to be higher than the ones for /gl/.

Looking at the other subfigures, one can observe that there are differences between initial and word boundary clusters on the one hand and medial clusters on the other hand. In the /pl/ items, the medial clusters (bold italics) tend to have higher ED_{diff} values and higher vowel compression values than either the initial or the word boundary clusters. To understand what this difference between medial and other clusters means, an example will be discussed.

A comparison between *plauschen* and *lauschen* (where /pl/ and /l/ occur initially) reveals that the tongue movement from cluster /l/ in *plauschen* to the

vowel is shorter in amplitude than the movement from singleton /l/ in *lauschen* to the vowel. In *geplauscht* vs. *gelauscht* (the medial cases), this difference in movement amplitude is more pronounced. Inspection of the tongue positions reveals that the /l/-sounds in *geplauscht*, *plauschen*, and *lauschen* are similar, but the /l/ in *gelauscht* has a higher tongue position (more /g/-like). The reason for that is again coarticulation: the /l/ in *gelauscht* is influenced by the word-initial velar stop. In *geplauscht* this influence exists as well, but it is less pronounced due to the greater distance between /g/ and /l/. Most of the words with medial clusters in the corpus start with the prefix *ge-*. The coarticulatory influence of this prefix seems to be responsible for the effect of cluster position (initial vs. medial) on vowel compression.

The difference between initial and medial clusters just discussed exists mainly for /pl/. In /kv/ and /gl/, the velar in the clusters obscures the influence of the velar in the prefix. A comparison between, for example, *gequert* and *gewehrt* reveals that the movement from /v/ to /e/ is slightly larger in the singleton item *gewehrt* than in the cluster item *gequert*. The difference, however, is not enormous because both labials are influenced by a velar: in *gewehrt* this velar is the word-initial one, in *gequert* it is rather the medial one. As a result, the two /v/ sounds in *gequert* and *gewehrt* are similar.

Looking at the corresponding initial onsets in *queren* and *wehren*, there is a difference in the movement amplitude of the CV movement as well, but this difference is larger. The CV movement in *wehren* is much larger than the one in *queren* because the labial in *wehren* is not influenced by any velar.

The word boundary clusters behave like the initials because the sounds preceding the word boundary clusters are all less coarticulatorily aggressive than the velar in the medials. In *knapp lagen* the aggressive initial velar is quite remote from the /l/. In *pack wehren* there are no aggressive sounds preceding the cluster at all.

Coarticulation can also explain the differences between lax vowels on the one hand and tense vowels and diphthongs on the other. Figure 13 shows the same data as Figure 12 but arranged by vowel type. Across clusters, lax vowel items have ED_{diff} values of around zero. Tense vowel items and diphthongs tend to have higher absolute ED_{diff} values. Since ED_{diff} and vowel compression are related, lax vowel items do not have much vowel compression.

Figure 13 also shows why it is hard to make general statements about items with different vowel types, such as ‘there is less vowel compression in lax vowel items than in tense vowel items’: tense vowel items and diphthong items can have either higher or lower ED_{diff} values than lax vowel items and thus more or less vowel compression. For /kv/ there is more vowel compression in diphthong and tense vowel items; for /gl/ there is less.

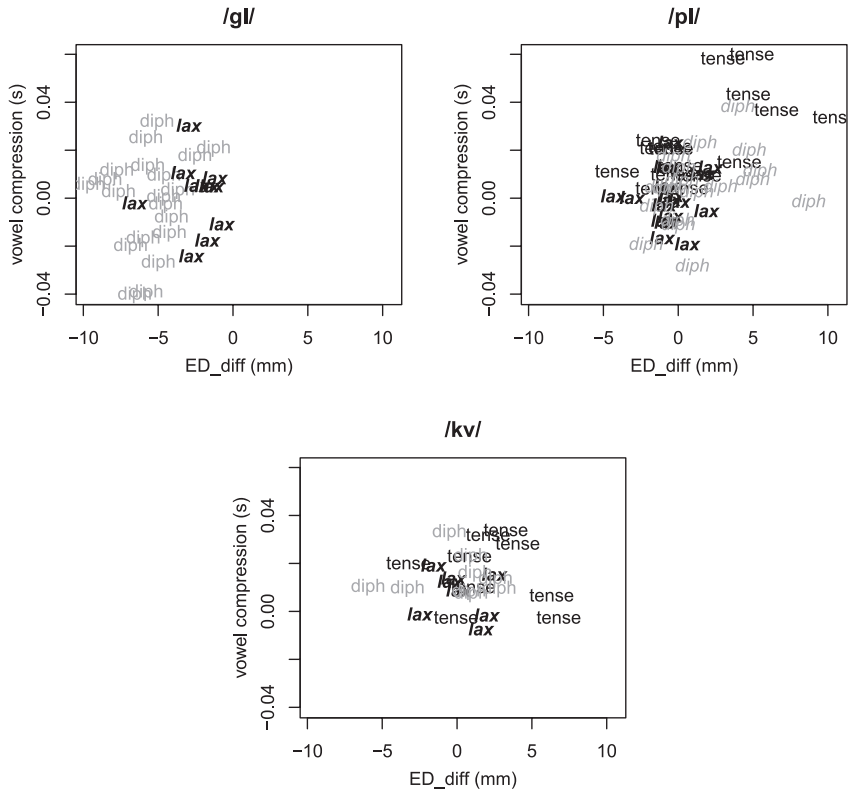

Fig. 13: ED_{diff} (abscissa) versus vowel compression (ordinate). Bold: lax vowel items; plain: tense vowel items; grey: diphthong vowel items. High ED_{diff} values: larger CV movement in the singleton item; low ED_{diff} values: larger CV movement in the cluster item. High compression values: CCV vowel is shorter than the CV vowel.

To summarize, coarticulatory factors seem to modulate the presence or absence of C-center stability. In some item pairs (e.g., *queren-wehren*), the CV movement is shorter in the CCV item than in the CV item. The vocalic tongue position is thus reached earlier in the CCV item than in the CV item. When a vowel compression analysis is carried out on items like this, one finds C-center stability. This is because, in that kind of analysis, the vowel is usually measured as the interval from plateau offset of the prevocalic consonant to plateau onset of the anchor consonant. This interval (from the prevocalic consonant to the anchor) comprises the CV movement. If that CV movement is longer in the CCV item than in the CV item, positive vowel compression is measured (C-center pattern).

4 Summary and discussion

4.1 Summary

The aim of the present study was to investigate the timing patterns in four German syllable onset clusters (/sk/, /pl/, /gl/, and /kv/) and the timing of the same clusters across a word boundary. Since German is a language that admits complex onsets, the C-center hypothesis predicts C-center stability for the onset clusters but not for the clusters across a word boundary.

Earlier studies generally used stability analysis and vowel compression analysis in order to investigate the C-center effect. When carrying out a stability analysis, the variability of the C-center to anchor interval across CCV and CV items, measured as standard deviation or relativized standard deviation, is compared to the variability of the right edge to anchor interval. A vowel compression analysis compares vowel durations of CCV and CV items.

For the German data analyzed here, the stability analysis showed that there are cases where the C-center to anchor interval is most stable, but that cases with right-edge stability are about equally as frequent. C-center stability is usually found for clusters with a small interconsonantal plateau lag (/sk/ and /gl/), and it is more frequent before tense vowels than before lax vowels or diphthongs. It is arguably more likely in medial cluster onsets than in initial cluster onsets. A very striking result was that C-center stability was frequently found in word boundary clusters. The vowel duration analysis gave slightly different results. A C-center effect was found for /sk/ and /kv/ but not for /gl/ and /pl/.

In both the stability analysis and the vowel compression analysis, the effect of segmental properties seemed to be more prominent than the stability patterns. To give an example, for /sk/ a C-center effect was always found, but for /pl/ it was almost never found. The stability analysis was found to be dependent on the C1-C2 lag duration: in line with earlier findings, C-center stability was found for clusters with a small interconsonantal plateau lag (/sk/ and /gl/). The small lag causes the C-center of the cluster to move towards the vowel, and as a result, the C-center of the cluster more easily lines up with the C-center of the singleton.

The vowel compression analysis is independent of the C1-C2 lag duration (except for the coarticulatory influence a more vs. less distant initial consonant has on the prevocalic consonant), but it is dependent on the segmental properties of the prevocalic consonant. Two classes of these segmental properties were discussed. The first is a difference in oral-laryngeal coordination between a singleton and a cluster consonant. For /sk/ we showed that the C-center effect

disappears when glottal activity, as opposed to lingual activity, is considered. We argued that the C-center effect found for lingual articulatory movements in /sk/ is unlikely the result of competitive coupling.

The second class of segmental properties concerns coarticulatory behaviour of the segments. Depending on the coarticulatory aggressiveness of the initial consonant of a cluster, the articulatory positions of the prevocalic and the singleton consonant differ. As a result, the movement from that consonant to the vowel differs in amplitude. If the CV movement in the cluster is shorter than the one in the singleton, this results in vowel compression (which would be considered as evidence for a C-center effect in a compression or stability analysis). In the reverse case, one finds vowel expansion (there would be no C-center effect in a compression or stability analysis). There is thus a correlation between movement amplitude differences between CCV and CV items and vowel compression.

Coarticulatory behaviour accounts for much of the variability found in the data. Not only does it explain the differences between the clusters, it also accounts for differences between initial and medial clusters and for the differences between vowel types: tense vowels have more extreme articulatory positions, and this influences the amplitude of the CV movement and consequently vowel compression.

Our data show that C-center stability can often be observed for clusters crossing word boundaries (e.g., in the item pair *lass Kater-Kater*). We also found that the C1-C2 lag is dramatically reduced when there is a word boundary in between the two cluster consonants. Analyses of the acoustic data suggest that this occurs in parallel with a loss of aspiration. Unaspirated sounds such as /s/ in /s#k/ are reduced in length when they precede a boundary. In this respect German behaves like English: Redford (2007) reports that English coda consonants are reduced in length and aspirated stops lose their aspiration. The finding of C-center stability in word boundary clusters can therefore be explained by the initial consonant or the C1-C2 lag being reduced in length. The C-center to anchor interval thereby gains in stability.

4.2 Discussion

The findings of the present study are largely in agreement with the results from earlier studies. /sk/ was frequently found to exhibit a C-center effect (e.g., Marin and Pouplier 2010; Marin 2011; Pouplier 2012). In line with Pouplier (2012), no C-center effect was found for German /pl/. This contrasts with studies on English /pl/, which was frequently found to exhibit a C-center effect (Browman and Goldstein 1988; Honorof and Browman 1995; Marin and Pouplier 2010). An explana-

tion for this contrast between English and German could be a difference in coarticulatory behaviour of English and German /l/. The two /l/ sounds differ in darkness: German /l/ is clearer and therefore has a higher tongue back. According to the DAC model, it should therefore be more resistant to coarticulation than dark /l/, so that the CV movement in German /pl/ and /l/ should be more similar in amplitude than the corresponding movement in English. A preliminary analysis of American English data recorded in our laboratory confirmed this hypothesis.

Bombien et al. (2010) compared EPG data of word-initial German /kl/, /sk/, /kn/, and /ks/. They show that there are lags between the consonantal plateaus for /kl/, /kn/, and /ks/, but there is some overlap for /sk/ (cf. their Figure 3). This is in line with our finding that the consonantal plateaus are very close in /sk/. Bombien (2011) presents EMA data on initial clusters with a lag of about 20 ms in /pl/ (compare his Figure 3.7), which is quite close to our measurements. Hoole et al. (2009) discuss EMA data of German /bl, gl, pl/ and /kl/ and report more overlap in the voiced clusters /bl/ and /gl/ than in the voiceless clusters /pl/ and /kl/. This is in line with our data, where clusters starting with voiceless consonants (/pl/ and /kv/) have considerably longer lags than the voiced cluster /gl/.

In line with the results from our C1-C2-lag analysis, Pouplier (2012) shows that the C-center effect can usually be found for clusters with small lags (/gm/ and /sk/ in her study), but not for clusters with large lags (/km/ and /pl/ in her study).

For the /sk/-/k/ contrast we suggest that the very clear C-center effect is the result of a difference in oral-laryngeal timing in singleton /k/ versus cluster /k/. In line with that, for other languages with aspirated stops, similar observations have been made. Browman and Goldstein (1988), Honorof and Browman (1995), and Goldstein et al. (2009) found a C-center effect for /sp/ in English, and Marin and Pouplier (2010) found one for /sk/ and /sp/ in English. Importantly, no C-center effect was observed for French /sp/ (Tilsen et al. 2012) or Italian /sp/ (Hermes et al. 2008), and we suggest that this is because French and Italian voiceless stops are frequently unaspirated.

Our results furthermore suggest that coarticulatory behaviour influences vowel compression. The presence or absence of a C-center effect depends on, among other things, the height of the vowel following the singleton and cluster onset. Without knowing the exact vocalic and consonantal positions measured in previous studies, it is difficult to generalize; however, what can be said is that in the data used in earlier studies, a dependence on the vowel height can be observed as well. Hermes et al. (2008) for example, found a C-center effect in Italian *rima-prima*, but in *rema-prema* the effect was less clear. The reason for that could

be that the jaw, and possibly also the tongue, is higher during /r/ in *prima* and *prema* than in *rima* and *rema* because of the bilabial, which is produced with a high jaw. In order to reach the high vowel /i/, the tongue might then have to travel a shorter distance in the cluster than in the singleton item, and this would cause the C-center effect. For the lower vowel /e/, this difference in movement amplitude might not exist.

To give a second example, Marin (2011) found for Romanian that the prevocalic consonant shifted towards the vowel in her /l/-series (/pl/, /kl/) and her /s/-series (/sp/, /sk/, /sm/), but not in her stop-series (/ks/, /kt/, /kn/, /ps/). In the stop series there was a shift in the opposite direction (away from the anchor) for /ks/, /kn/, and /ps/, and no shift for /kt/. What is striking, however, is that this difference between the /l/- and /s/-series on the one hand and the stop series on the other corresponds with different vowels in the items recorded. All the items in the /l/- and /s/-series had low vowels, whereas the vowel varied in the stop series (/e/ after /ks/ and /kn/, /i/ after /kt/, /a/ after /ps/). One could say that a leftward shift is found if the vowel is /e/, a rightward shift is found if the vowel is a low one (with the exception of /ps/), and no shift is found if the vowel is /i/. With regard to the /i/-/e/ contrast, the results of this study are comparable to the *prema-prima* contrast in Hermes et al. (2008): the prevocalic consonant is more likely to shift towards the vowel if the vowel is an /i/ than if it is an /e/. What differs in the two studies is the absolute values. Hermes et al. found a leftward shift for /i/ and no shift for /e/; Marin found no shift for /i/ and a rightward shift for /e/.

Our German data contrast partly with the Italian data presented in Hermes et al. (2013). Hermes et al. compared leftward and rightward shifts of the onset consonants in obstruent-liquid clusters and /s/-obstruent clusters. They show that the prevocalic cluster consonant in the obstruent-liquid clusters generally shifts towards the vowel (C-center effect) whereas it does not in the /s/-obstruent cluster (no C-center effect). As in their earlier work, Hermes et al. suggest that this difference is the result of the extrasyllabicity of /s/ in the respective clusters. To give an example, /l/ in *plina* is closer to /i/ than /l/ in *lina*. /p/ in *spina*, however, is not closer to the vowel than /p/ in *pina*. What is remarkable about Hermes et al.'s data, however, is that there are differences in coarticulatory resistance. All the obstruent-liquid clusters (the ones showing a C-center effect) consist of sounds with low coarticulatory resistance (liquids or labial obstruents). Although an in-depth analysis of the data is needed to be definite about the reasons for the difference between German and Italian here, one can speculate that the path the tongue has to travel is optimized due to coarticulation. In contrast to that, in the /s/-obstruent clusters, there is at least one sound with high coarticulatory resistance, namely /s/. The path the tongue has to travel is therefore less optimal for preventing a C-center effect.

Comparing Hermes et al.'s results and the results from the present study directly, there is an obvious contradiction: in the Italian data, a C-center effect is found in /pl/ (*plina-lina*), but in the German data (e.g., *plagen-lagen*), there is none. One possible explanation is the height of the vowel. In *plina* the tongue needs to move upwards after the cluster, and it is already high due to the coarticulatory influence of /p/. The path the tongue has to travel from the prevocalic consonant to the vowel can be assumed to be shorter in *plina* as compared to *lina*, favouring a C-center effect. In *plagen* (and the other /pl/ examples from the present study), the tongue needs to travel downwards to reach the vowel. The path to travel is therefore longer in the cluster word as compared to the singleton word, and this disfavors a C-center effect.

It would be worth investigating whether the results found for simplex onset languages can be explained by taking into account the movement amplitude from C to V. Goldstein et al. (2007), for example, found no shift towards the vowel in Tashlhiyt Berber *mun-smun-tsmun*. The target words were produced following a low vowel in the carrier phrase. Since the nasal has a low coarticulatory aggressiveness, what has to be compared is the movement amplitude of the tongue from /a/ to /u/ for *mun*, and the movement amplitudes from /s/ and /ts/ to /u/ for the other two items. If they are comparable in magnitude, this would explain the right-edge stability.

Similarly, Hermes et al. (2011) found a significant reduction of the right-edge to anchor interval in Berber *fik* as compared to *tkfik* for one speaker (although the shifts in *fik-kfik* and *kfik-tkfik* did not reach significance), but a significant increase of this interval in *kif* vs. *lkif*. It is possible that the movement amplitude from /k/ to /i/ was shorter in the first item because the /k/ is produced in the vicinity of the /i/ tongue position. In *lkif* the velar might be influenced by /l/ so that it is produced at a position further away from /i/.

In a simplex onset language, Moroccan Arabic, Shaw et al. (2011) found evidence for right-edge stability predominately, but also cases where (three out of four) speakers, who in most contexts showed right-edge stability, exhibited C-center stability. In these latter 'exceptional' cases, Shaw et al. observed that the syllable duration in the CV sequence was longer compared to the CCV sequence (equivalently, the CV portion of the phonetic string compressed in duration from the CV to the CCV context). Shaw et al. then simulated the predictions of a simplex onset organization under various prosodic conditions, including the case of syllabic compression found in that subset of their data. The results of the simulations indicated that, under syllabic compression, simplex onset organization in fact predicts that C-center stability should improve and right-edge stability should degrade, as seen in their experimental data. However, the opposite prediction is made for complex onset organization. Given these results, Shaw et al. reasoned

that static heuristics such as ‘C-center stability means complex onset organization’ and ‘right-edge stability means simplex onset organization’ are too simple to serve as reliable diagnostics of syllabic organization. Instead, diagnosis should be based on patterns of change in stability as various parameters reflecting prosodic modulations are varied. They thus proposed that invariances characterizing the relation between syllabic organization and phonetics are dynamic as opposed to static.

Gafos et al. (2014) pursued further analysis of the experimental and computational result of Shaw et al. (2011). In their study, the statistics of syllabic organization were expressed in equations involving estimates of continuous phonetic parameters expressing the timing of consonants and vowels: consonantal plateau durations, vowel durations, and their variances. These equations, which formally describe the link between a syllabic parse and its continuous phonetics, were used to expose the whole range of the phonetic manifestations of different syllabic organizations. Using this approach, Gafos et al. derived a number of previous experimentally observed and simulation results. Specifically, they derived the canonical phonetic manifestations of simplex onsets (as right-edge stability) but also the result that, under certain conditions, the phonetic indices of the simplex onset organization change to a range of values characteristic of complex onset organization.

The present work on German, a language with complex onsets, does not systematically find a C-center effect and therefore adds to the evidence (in the line of Shaw et al. and Gafos et al.) that C-center stability may not, in itself, uniquely characterize a certain syllabic parse, complex or simplex. The two studies reviewed above propose new ways in which one can diagnose the syllabic parse in variable phonetic data, but both focus on simplex onsets. Hence, an understanding of how data from a complex onset language, as with the German data in this paper, could fit in these approaches is left for future work.

4.3 Conclusion and outlook

Taken together, the results of the present study show that, at least for German, evidence for a systematic influence of the phonological parse on the timing of articulatory gestures, as it can be measured by the presence or absence of a C-center effect, is difficult to find. As in many earlier studies, there are several counter-examples for the C-center effect in our data: the effect was not found in many onsets where it should be observed according to the C-center hypothesis. Instead, a C-center effect was found in cases where it should not be observed (word-boundary clusters). Moreover, the results indicate that phonetic properties

of the segments involved go some way in explaining the articulatory patterns observed.

Specifically, in the present study, we identified phonetic reasons which explain both the presence and the absence of the C-center effect in the data. When the coarticulatory surroundings happen to increase the amplitude of the C-V movement in the CV item but to decrease it in the CCV item, a C-center effect becomes more likely. Coarticulation can also account for the fact that in many contexts the C-center effect is found in more than the 50% of cases in which it should be found if the distribution of C-center stability versus right-edge stability were purely random. A vowel in a syllable with a singleton onset is subject to less coarticulatory influence than a vowel in a syllable with a cluster onset, simply because the likelihood of having an onset consonant with high coarticulatory aggressiveness is higher if there are two consonants than if there is just one. A vowel following a cluster is therefore more often subject to coarticulation than a vowel following a singleton; the vowel following a cluster is thus more consonant-like, which leads to a reduction in the path from the consonantal tongue position to the vocalic tongue position.

The results of the present study suggest that the C-center hypothesis must be revised, if it is regarded to be valid for all natural languages. It is possible that syllabic parsing does not percolate through to the observables of speech production, the motion of electromagnetic coils in the present case. Research related to the effect should therefore make use of methods to which the central representational mechanism of the phonological model – be it gestures or phones – is accessible.

Acknowledgments: Thanks are due to two anonymous reviewers and the editors for valuable feedback. This work was supported by ERC Grant 249440 to A. I. Gafos.

References

- Baayen, Rolf H. 2011. *Analyzing linguistic data: a practical introduction to statistics using R*. Cambridge: Cambridge University Press.
- Beckman, Mary E. 1986. Stress and non-stress accent. *Netherlands Phonetic Archives*. Dordrecht, Holland: Foris.
- Beringer, Nicole, & Florian Schiel. 1999. Independent automatic segmentation of speech by pronunciation modeling. In *Proceedings of the 14th International Congress of Phonetic Sciences*, 1653–1656. San Francisco.
- Boersma, Paul, & David Weenink. 2012. Praat, a system for doing phonetics by computer. www.PRAAT.org

- Bombien, Lasse. 2011. Segmental and prosodic aspects in the production of consonant clusters – on the goodness of clusters. München: Ludwig-Maximilians-Universität doctoral dissertation.
- Bombien, Lasse, & Philip Hoole. 2013. Articulatory overlap as a function of voicing in French and German consonant clusters. *The Journal of the Acoustical Society of America* 134(1). 539–550.
- Bombien, Lasse, Christine Mooshammer, Philip Hoole, & Barbara Kühnert. 2010. Prosodic and segmental effects on EPG contact patterns of word-initial German clusters. *Journal of Phonetics* 38. 388–403.
- Bortz, Jürgen. 1999. Statistik für Sozialwissenschaftler. Berlin: Springer.
- Browman, Catherine, & Louis Goldstein. 1988. Some notes on syllable structure in articulatory phonology. *Phonetica* 45. 140–155.
- Browman, Catherine, & Louis Goldstein. 2000. Competing constraints on intergestural coordination and self-organization of phonological structures. *Les Cahiers de l'ICP, Bulletin de la Communication Parlée* 5. 25–34.
- Brunner, Jana, Susanne Fuchs, & Pascal Perrier. 2011. Supralaryngeal control in Korean velar stops. *Journal of Phonetics* 39. 178–195.
- Byrd, Dani. 1995. C-centers revisited. *Phonetica* 52(4). 285–306.
- Campbell, W. N., & Stephen D. Isard. 1991. Segmental durations in a syllable frame. *Journal of Phonetics* 19. 37–47.
- Dell, François, & Mohamed Elmedlaoui. 1996. On consonant releases in Imdlawn Tashlhiyt Berber. *Linguistics* 34. 357–395.
- Gafos, Adamantios. 2002. A grammar of gestural coordination. *Natural Language and Linguistic Theory* 20(2). 269–337.
- Gafos, Adamantios I., Simon Charlow, Jason A. Shaw, & Philip Hoole. 2014. Stochastic time analysis of syllable-referential intervals and simplex onsets. *Journal of Phonetics* 44. 152–166.
- Giegerich, Heinz. 1992. *English phonology*. Cambridge: Cambridge University Press.
- Goldstein, Louis, Ioana Chitoran, & Elisabeth Selkirk. 2007. Syllable structure as coupled oscillator modes: evidence from Georgian vs. Tashlhiyt Berber. *Proceedings of the XVIth International Congress of Phonetic Sciences, Saarbrücken, Germany*. 241–244.
- Goldstein, Louis, Hosung Nam, Elliot Saltzman, & Ioana Chitoran. 2009. Coupled oscillator planning model of speech timing and syllable structure. In Gunnar Fant, Hiroya Fujisaki, & Jiaxuan Shen (eds.), *Frontiers in Phonetics and Speech Science*, 239–250. Beijing: The Commercial Press.
- Hawkins, Sarah. 1992. An introduction to task dynamics. In Gerard Docherty & D. Robert Ladd (eds.), *Papers in Laboratory Phonology II: Gesture, Segment, Prosody*, 9–25. Cambridge: Cambridge University Press.
- Hermes, Anne, Martine Grice, Doris Mücke, & Hendrik Niemann. 2008. Articulatory indicators of syllable affiliation in word initial consonant clusters in Italian. *Proceedings of the 8th International Seminar on Speech Production, Strasbourg, France*. 433–436.
- Hermes, Anne, Doris Mücke, & Martine Grice. 2013. Gestural coordination of Italian word initial clusters – the case of ‘impure s’. *Phonology* 30(1). 1–25.
- Hermes, Anne, Rachid Ridouane, Doris Mücke, & Martine Grice. 2011. Kinematics of syllable structure in Tashlhiyt Berber: The case of vocalic and consonantal nuclei. *Proceedings of the 9th International Seminar on Speech Production, Montréal, Canada*, 401–408.

- Honorof, Douglas, & Catherine Browman. 1995. The center or edge: How are consonant clusters organized with respect to the vowel? *Proceedings of the 13th International Congress of Phonetic Sciences (Stockholm)* 3. 552–555.
- Hoole, Philip. 2006. Experimental studies of laryngeal articulation. Part II: Laryngeal-oral coordination in consonant sequences. University of Munich. www.phonetik.uni-muenchen.de/~hoole/pdf/habilpgg_chap_all.pdf
- Hoole, Philip. 2007. *mtnew*. www.phonetik.uni-muenchen.de/~hoole/articmanual
- Hoole, Philip, Lasse Bombien, Barbara Kühnert, & Christine Mooshammer. 2009. Intrinsic and prosodic effects on articulatory coordination in initial consonant clusters. In Gunnar Fant, Hiroya Fujisaki, & Jiaxuan Shen (eds.), *Frontiers in phonetics and speech science*, 275–286. Beijing: The Commercial Press.
- Jessen, M. 1999. *Phonetics and phonology of tense and lax obstruents in German* (Studies in Functional and Structural Linguistics 44). Philadelphia: Benjamins.
- Kohler, Klaus J. 2005. Form and function of non-pitch accents. *Arbeitsberichte des Instituts für Phonetik und digitale Signalverarbeitung der Universität Kiel* 35a. 97–123.
- Lehiste, Ilse. 1970. *Suprasegmentals*. Cambridge, MA: MIT Press.
- Marin, Stefania. 2011. Organization of complex onsets in Romanian. *Proceedings of the 9th International Seminar on Speech Production, Montréal, Canada*. 179–186.
- Marin, Stefania, & Marianne Pouplier. 2010. Temporal organization of complex onsets and codas in American English: Testing the predictions of a gestural coupling model. *Motor Control* 14(3). 380–407.
- McCarthy, John J., & Alan S. Prince. 1993. Generalized alignment. In *Yearbook of Morphology*, 79–153. Dordrecht, The Netherlands: Kluwer.
- Mooshammer, Christine, Philip Hoole, & Barbara Kühnert. 1995. On loops. *Journal of Phonetics* 23. 3–21.
- Nam, Hosung, & Elliot Saltzman. 2003. A competitive, coupled oscillator model of syllable structure. *Proceedings of the 15th International Congress of Phonetic Sciences* 2253–2256.
- Pinheiro, José, & Douglas Bates. 2000. *Mixed-effects models in S and S-PLUS*. New York: Springer.
- Pouplier, Marianne. 2012. The gestural approach to syllable structure: universal, language- and cluster-specific aspects. In Susanne Fuchs, Melanie Weirich, Daniel Pape, & Pascal Perrier (eds.), *Speech planning and dynamics*, 63–96. Berlin: Peter Lang.
- R Development Core Team. 2008. R: a language and environment for statistical computing. Vienna, Austria: R Foundation for Statistical Computing. <http://www.R-project.org>
- Recasens, Daniel. 1999. Lingual coarticulation. In William J. Hardcastle & Nigel Hewlett (eds.), *Coarticulation: Theory, Data and Techniques*, 80–104, Cambridge: Cambridge University Press.
- Recasens, Daniel. 2012. A study of jaw coarticulatory resistance and aggressiveness for Catalan consonants and vowels. *Journal of the Acoustical Society of America* 132. 412–420.
- Recasens, Daniel, Maria Dolores Palarès, & Jordi Fontdevila. 1997. A model of lingual coarticulation based on articulatory constraints. *Journal of the Acoustical Society of America* 102(1). 544–561.
- Redford, Melissa. 2007. Word-internal versus word-peripheral consonantal duration patterns in three languages. *Journal of the Acoustical Society of America* 121. 1667–1678.
- Reichel, Uwe. 2012. PermA and Balloon: Tools for string alignment and text processing. In *Proceedings of Interspeech*, paper no. 346. Portland, Oregon.

- Ridouane, Rachid, Susanne Fuchs, & Philip Hoole. 2006. Laryngeal adjustments in the production of voiceless obstruent clusters in Berber. In Jonathan Harrington & Marija Tabain, *Speech production: models, phonetic processes, and techniques*, 275–297, New York: Psychology Press.
- Schiel, Florian. 2004. MAUS goes iterative. In *Proceedings of the Fourth International Conference on Language Resources and Evaluation*, 1015–1018, Lisbon, Portugal.
- Schiel, Florian, Christoph Draxler, & Jonathan Harrington. 2011. Phonemic segmentation and labelling using the MAUS technique. New Tools and Methods for Very-Large-Scale Phonetics Research Workshop, University of Pennsylvania.
- Shaw, Jason, Adamantios Gafos, Philip Hoole, & Chakir Zeroual. 2009. Syllabification in Moroccan Arabic: evidence from patterns of temporal stability in articulation. *Phonology* 26. 187–217.
- Shaw, Jason, Adamantios Gafos, Philip Hoole, & Chakir Zeroual. 2011. Dynamic invariance in the phonetic expression of syllable structure. *Phonology* 28(3), 455–490.
- Sokal, Robert, & Carlos Braumann. 1980. Significance tests for coefficients of variation and variability profiles. *Systematic Zoology* 29(1). 50–66.
- Sproat, Richard, & Osamu Fujimura. 1993. Allophonic variation in English /l/ and its implications for phonetic implementation. *Journal of Phonetics* 21. 291–311.
- Tilsen, Sam, Draga Zec, Christina Bjorndahl, Becky Butler, Marie-Josée L'Esperance, Alison Fisher, Linda Heimisdottir, Margaret Renwick, & Chelsea Sanker. 2012. A cross-linguistic investigation of articulatory coordination in word-initial consonant clusters. *Cornell Working Papers in Phonetics and Phonology*. 51–81.
- Wiese, Richard. 1996. *The phonology of German*. Oxford: Oxford University Press.
- Yoshioka, Hirohide, Anders Löfqvist, & Hajime Hirose. 1981. Laryngeal adjustments in the production of consonant clusters and geminates in American English. *Journal of the Acoustical Society of America* 70. 1615–1623.

Appendix

Table A.1: Speech material. Words with asterisks are nonce words.

Cluster	Vowel	#(C)CV	C#CV	#X.ʹ(C)CV
/gl/	lax	<i>glänzen</i>	final dev.	<i>geglänzt</i>
		<i>/ˈglɛn.tʂən/</i>		<i>/gə.ˈglɛntst/</i>
		‘to shine’		‘shone’
		<i>Lenze</i>		<i>gelenzt</i>
		<i>/ˈlɛn.tzə/</i>		<i>/gə.ˈlɛntst/</i>
		‘springs’ (pl.)		‘relaxed’ (colloquial)
tense		<i>glauben</i>		<i>geglaubt</i>
		<i>/ˈglaʊ.bən/</i>		<i>/gə.ˈglaʊpt/</i>
		‘to believe’		‘believed’
		<i>Lauben</i>		<i>belaubt</i>
		<i>/ˈlaʊ.bən/</i>		<i>/bə.ˈlaʊpt/</i>
		‘bowers’		‘leafy’
diph		<i>gleiten</i>		<i>begleiten</i>
		<i>/ˈglai.tən/</i>		<i>/bə.ˈglai.tən/</i>
		‘to glide’		‘to accompany’
		<i>leiten</i>		<i>verleiten</i>
		<i>/ˈlai.tən/</i>		<i>/fɛɐ̯.ˈlai.tən/</i>
		‘to lead’		‘to seduce’
/kv/	lax	<i>Quelle</i>	<i>pack Welle</i>	<i>gequellt</i>
		<i>/ˈkvɛlə/</i>	<i>/pak ˈvɛlə/</i>	<i>/gə.ˈkvɛlt/</i>
		‘source’	‘to grab a wave’	‘swelled’
		<i>Welle</i>		<i>gewellt</i>
		<i>/ˈvɛlə/</i>		<i>/gə.ˈvɛlt/</i>
		‘wave’		‘curled’
tense		<i>queren</i>	<i>pack wehren</i>	<i>gequert</i>
		<i>/ˈkve:.rən/</i>	<i>/pak ˈve:.rən/</i>	<i>/gə.ˈkve:ɐ̯t/</i>
		‘to cross’	‘to grab	‘crossed’
		<i>wehren</i>	crossing’	<i>gewehrt</i>
		<i>/ˈve:.rən/</i>		<i>/gə.ˈve:ɐ̯t/</i>
		‘to resist’		‘resisted’
diph		<i>*queilen</i>	<i>pack weilen</i>	<i>*verqueilen</i>
		<i>/ˈkvai.lən/</i>	<i>/pak ˈvai.lən/</i>	<i>/fɛɐ̯.ˈkvai.lən/</i>
		-nonce-	‘to grab	-nonce-
		<i>weilen</i>	tarrying’	<i>verweilen</i>
		<i>/ˈvai.lən/</i>		<i>/fɛɐ̯.ˈvai.lən/</i>
		‘to tarry’		‘to linger’

Cluster	Vowel	#(C)CV	C#CV	#X. '(C)CV
/pl/	lax	<i>Plätze</i> /'plɛtsə/ 'places'	<i>knapp Lätze</i> /knap 'lɛtsə/ 'scarce bibs'	<i>geplättet</i> /gə.'plɛtət/ 'flattened'
		<i>Lätze</i> /'lɛtsə/ 'bibs'		<i>verletzen</i> /fɛɐ.'lɛtsən/ 'to hurt'
	tense	<i>plagen</i> /'pla:.gən/ 'to pester'	<i>knapp lagen</i> /knap 'la:.gən/ 'scarce lying'	<i>geplagt</i> /gə.'pla:kt/ 'pestered'
		<i>lagen</i> /'la:.gən/ 'to lay'		<i>Gelage</i> /gə.'la:gə/ 'binge'
diph		<i>plauschen</i> /'plau.fən/ 'to chat'	<i>knapp</i> <i>lauschen</i> /knap 'lau.fən/ 'scarce	<i>geplauscht</i> /gə.'plauʃt/ 'chatted'
		<i>lauschen</i> /'lau.fən/ 'to eavesdrop'	<i>eavesdropping'</i>	<i>geplauscht</i> /gə.'lauʃt/ 'eavesdropped'
/sk/	lax	<i>Sketche</i> /'skɛtʃə/ 'sketches'	<i>lass Ketchup</i> /las 'kɛtʃəp/ 'leave ketchup'	<i>gesketcht</i> /gə.'skɛtʃt/ 'sketched'
		<i>Ketchup</i> /'kɛtʃəp/ 'ketchup'		<i>gecatcht</i> /gə.'kɛtʃt/ 'caught'
	tense	<i>Skat</i> /'ʃka:t/ 'skat'	<i>lass Kater</i> /las 'ka:.tə/ 'leave tomcat'	<i>geskatet</i> /gə.'ska:.tət/ 'played skat'
		<i>Kater</i> /'ka:.tə/ 'tomcat'		<i>verkatert</i> /fɛɐ.'ka:.tɛt/ 'crapulent'
	diph	<i>skypen</i> /'skai.pən/ 'to skype'	<i>lass Keime</i> /las 'kai.mə/ 'leave germs'	<i>geskyped</i> /gə.'skai.pt/ 'skyped'
		<i>Keime</i> /'kai.mə/ 'germs'		<i>gekeimt</i> /gə.'kaimt/ 'sprouted'